

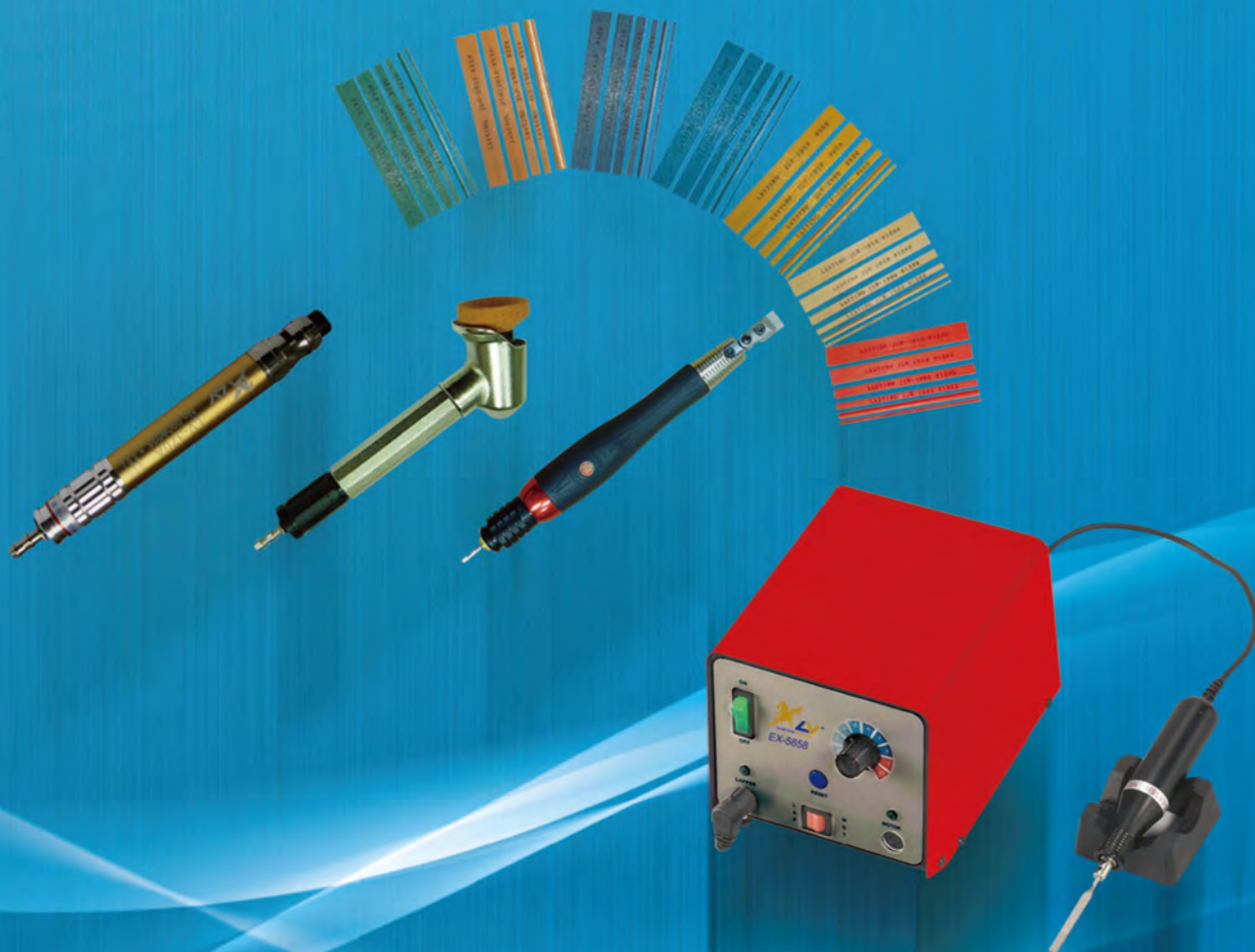

# 研 磨 工 具

# Grind Tools





**專業技術團隊  
完善的服務理念**

**Expert Technical Team  
Comprehensive Service Concepts**

創立於1995年的元駿國際有限公司，專業設計製造各式超音波研磨機與研磨耗材等。

Established in 1995, LV International Co., Ltd. specializes in design and manufacturing of various ultrasonic lapping machines and consumable materials for grinding, etc.

歷經多年來的辛勤耕耘，我們已累積了豐富的製造技術與行銷經驗。我們深切體認唯有為客戶提供精良的產品與具有競爭力的價位，才能贏得客戶的信賴。而這也就是元駿公司持續努力的方針。

Through the years of hard cultivation, we have accumulated comprehensive experience in manufacturing and marketing. We have come to deeply understand that the only way to obtain customers' dependability is to offer the excellent quality of product and comprehensive price. And this is the direction that we take at LV.

**網路行銷 Internet Marketing**

元駿公司架構網路行銷體系，配合電子型錄，提供客戶更多元化，更方便的訂購。

LV has set up an internet marketing system combined with e-catalogues, providing customers more flexible and more convenient ordering.



**元駿公司概况 Company Profile**

創立時間：1995年

Date of Establishment: 1995

資本額：3000萬台幣

Invested Capital: NT\$30 million

員工人數：52人

Number of Employees: 52

生產廠房：台北廠與台中廠

Production Facilities: Taipei and Taichung Factories

**銷售產品 Sales Products**

- 超音波研磨機 Ultrasonic lapping machines
- 氣動工具 Air tools
- 各類研磨耗材 (超級油石、鑽石膏、羊毛輪...等)  
Various consumable materials for grinding  
(super oil stones, diamond compounds and felt bobs, etc.)



**P1- P3**  
電動超音波研磨機  
*Ultrasonic Lapping Machine*



**P4-P7**  
纖維油石  
*Ceramic Fiber Stone*



**P8-P9**  
電動研磨機  
*Electric Grinders*



**P10-P15**  
氣動工具系列  
*Precision Air Grinder*



**P16-P22**  
鑽石鏢刀系列  
*Diamond Files*



**P23-P26**  
鑽石磨棒系列  
*Diamond & CBN Mounted Points*

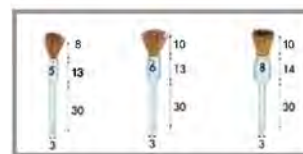

**P27-P28**  
超級磨料種類  
*Kind of Super Abrasive*



**P29-P30**  
鑽石修刀  
*Diamond Dressers Tools*



**P31**  
鑽石油石  
*Diamond Polishing Stones*



**P32-P33**  
模具油石  
*Grinding Oil Stone for Mold*



**P34**  
鑽石膏(高濃度)  
*Heavy Diamond Compounds*



**P35-P37**  
德國羊毛輪  
*Felt Bobs*



**P38-39**  
棕刷系列  
*Brush Series*



**P40-P41**  
粉紅色帶柄砂輪. 彈性帶柄砂輪  
*Pink Mounted Points. Elastic Mounted Points*



**P42-P48**  
鎢鋼滾磨刀  
*Solid Carbide*



## Ultrasonic Lapping Machine

### EX-6868 電動超音波研磨機 CE



標準配備 Standard Accessories



- ★ 超音波及電動手機雙功率輸出，提供您多重功能之各種研磨及拋光作業。
- ★ 本機器提供超音波、電動旋轉雙手機，其他的電動手機亦可供應。
- ★ 最大80瓦之輸出，提供高效率的研磨、拋光性能。

- ▲ This dual-function machine provides you the versatility of both ultrasonic and mechanical polishing.
- ▲ Each unit includes ultrasonic and straight rotary handset, other mechanical handsets available as separate option.
- ▲ Max. 80 watts output, provides excellent polishing and finishing performance.

#### EX-6868 規格

輸入電壓 Power Input	發振頻率 Osc Frequency	消耗功率 Power Input	輸出功率範圍 Output Power Range	尺寸 Size (mm)	發振電源 供應器重量 Power Supply Weight
AC110V (60/50 Hz) AC230V (60/50 Hz)	25K Hz~40K Hz Auto Sweep	80w max	超音波出力 Ultrasonic Output : 8w~45w 電動工具 Electric Tool: Dc 7V~35V (1Amp)	寬 X 長 X 高 W X L X H 180 x 220 x 155	4.7kg (±0.2kg)

#### 手握式研磨機 Hand Type Grinder

行程 Travel	研磨頭牙距 Grinding Head Thread Dis.	重量 Weight
16~50um	m6 X p1.0mm	280g (±30g)

#### 研磨頭拆卸工具組 Grinding Head Operation Tool Kits

開口板手 Open Wrench	六角板手 Hexagon Wrench
#10 and #8	#1.5 and #2.5



## Ultrasonic Lapping Machine

### EX-5858 電動超音波研磨機 CE



標準配備 Standard Accessories



選購配備  
Optional Accessories



- ★ 超音波及電動手機雙功率輸出，提供您多重功能之各種研磨及拋光作業。
- ★ 最大45瓦之輸出，提供高效率的研磨、拋光性能。
- ★ 無段超因波輸出，滿足各種加工需求。

- ▲ This dual-function machine provides you the versatility of both ultrasonic and mechanical polishing.
- ▲ Max. 45 watts output, provides excellent polishing and finishing performance.
- ▲ Continuous ultrasonic output to accommodate different types of tools and applications.

#### EX-5858 規格

輸入電壓 Power Input	發振頻率 Osc Frequency	消耗功率 Power Input	輸出功率範圍 Output Power Rang	尺寸 Size (mm)	發振電源 供應器重量 Power Supply Weight
AC110V (60/50 Hz) AC230V (60/50 Hz)	25K Hz~40K Hz Auto Sweep	45w max	超音波出力 Ultrasonic Output : 5w~35w 電動工具 Electric Tool: Dc 7V~35V (1Amp)	寬 X 長 X 高 W X L X H 150 x 180 x 140	2.4kg (±0.2kg)

#### 手握式研磨機 Hand Type Grinder

行程 Travel	研磨頭牙距 Grinding Head Thread Dis.	重量 Weight
16~37um	m6 X p1.0mm	190g (±30g)

#### 研磨頭拆卸工具組 Grinding Head Operation Tool Kits

開口板手 Open Wrench	六角板手 Hexagon Wrench
#10 and #8	#1.5 and #2.5



## Ultrasonic Lapping Machine

### EX-1818 電動超音波研磨機 CE

選購配備  
Optional Accessories



- ★ 具有可信賴的品質及良好性能的全新設計機種。
- ★ 誘人的價格，打破超音波研磨機是很昂貴的觀念。
- ★ 除了超音波研磨外，且可用於電子業，做電路板(PCB)之電子迴路修改及寶石業之精細雕刻、研磨。
- ▲ New design with vastly improved reliability and overall performance.
- ▲ Competitively priced, with reduced long term operation cost.
- ▲ Not only effective for lapping but also slithering printed circuit board (PCB) for circuit alteration.

#### EX-1818 規格

輸入電壓 Power Input	發振頻率 Osc Frequency	消耗功率 Power Input	輸出功率範圍 Output Power Range	尺寸 Size (mm)	發振電源 供應器重量 Power Supply Weight
AC110V (60/50 Hz) AC230V (60/50 Hz)	20K Hz~30K Hz Auto Sweep	35w max	5w~30w	寬 X 長 X 高 W X L X H 105 x 193 x 70	1.6kg (±0.1kg)

手握式研磨機 Hand Type Grinder			研磨頭拆卸工具組 Grinding Head Operation Tool Kits	
行程 Travel	研磨頭牙距 Grinding Head Thread Dis.	重量 Weight	開口扳手 Open Wrench	六角扳手 Hexagon Wrench
10~30 um	m6 X p1.0mm	235g (±30g)	#8	#2.5



## Ceramic Fiber Stones

### CERATON 超級纖維油石



粒度與顏色 / Grit size & color code:

粒度 Grit size	#180	#250	#280	#360	#400	#500	#700	#1000	#1200
顏色 Color	咖啡色 Brown	橘色 Orange	黑色 Black	海軍藍 Navy Blue	藍色 Blue	綠色 Green	黃色 Yellow	粉色 Pink	紅色 Red
代號/Code	C	O	D	N	B	G	Y	P	R

\* 訂製品 / customized: #500、#1000

規格 / Specifications:

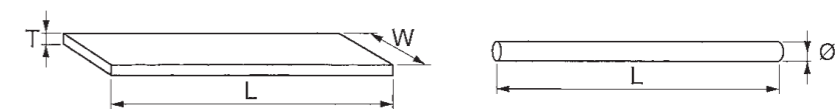

T x W (ØD)	粒度與編號 Grit Size & Order No.								
	#180	#250	#280	#360	#400	#500	#700	#1000	#1200
1 x 4	CSBr-1004	CSOr-1004	CSBL-1004	CSN-1004	CSB-1004	CSG-1004	CSY-1004	CSP-1004	CSR-1004
1 x 6	CSBr-1006	CSOr-1006	CSBL-1006	CSN-1006	CSB-1006	CSG-1006	CSY-1006	CSP-1006	CSR-1006
1 x 10	CSBr-1010	CSOr-1010	CSBL-1010	CSN-1010	CSB-1010	CSG-1010	CSY-1010	CSP-1010	CSR-1010
Ø2.35	CGBr-23	CGOr-23	CGBL-23	CGN-23	CGB-23	CGG-23	CGY-23	CGP-23	CGR-23
Ø3	CGBr-30	CGOr-30	CGBL-30	CGN-30	CGB-30	CGG-30	CGY-30	CGP-30	CGR-30

\* 訂製品 / customized: Ø2.35

粒度使用建議 / Recommendation:

粒度 / Grit size	使用建議 / Applications
#180、#250、#280	模具放電加工後之硬化表層去除及機械切削粗糙刀痕之去除 To remove the rough machining surface or hard EDM scale of tool and die steels.
#360、#400、#500	細微加工痕跡之去除及一般拋磨 General lapping of finer surface scratch line of tool & die steels.
#700、#1000、#1200	精細研磨或鏡面處理前之拋光 Fine polishing & finishing.
Ø3.0mm	可搭配刻磨機當成研磨棒使用(長度勿超過50mm長)，亦可將之磨尖用於細微角落或窄縫處之研磨 It can be used like grinding point(max. length 50mm), or by sharpening it for detail lapping.

\* 使用纖維油石時，請將工具與工件成30°~45°，端面研磨效果最佳。

\* In order to reach the best performance, we recommend that the stone should be held up-right, making an angle of approx. 30°~45° to the work-piece.



## Mini Ceramic Fiber Stones

### CERATON 迷你纖維油石

迷你纖維油石是將纖維油石切成細微尺寸，從0.5x0.5 mm到1x2 mm。專門使用於各種模具之細微部位或是其他類似之加工。由於陶瓷纖維具有高抗折強度，可解決一般油石或紅寶石易斷之困擾。

用途：  
迷你纖維油石可適用於各種模具之研磨及各種零件之精細拋光。尤其是雕刻部之加工，微小肋部，模角部精細拋磨，以及各種微細或複雜部位之加工。

Mini Ceramic Fiber Stones are cut by ceramic fiber stone, their size from 0.5 x 0.5mm to 1 x 2mm. Ideal for various mold and dies detail lapping. Traditional oil stone and ruby stones in such a small sizes are very easy to break, while mini ceramic stone provides high strength and high elasticity. Due to its high resistance to breakage, it solves the problem of using these stones.

Applications:  
It is good for all type of molds and dies fine and super fine finishing. Especially for engraving parts, slight ribs, R ribs, corners, complicated area and details. Additionally, for all other tool parts that need detailed lapping, our mini ceramic fiber stone makes excellent tools.

#### 粒度與顏色 / Grit size & color code:

粒度 Grit size	#250	#400	#700	#1200
顏色 Color				
	橘色 Orange	藍色 Blue	黃色 Yellow	紅色 Red
代號/Code	<b>O</b>	<b>B</b>	<b>Y</b>	<b>R</b>

#### 規格 / Specifications:

T x W x L (øD x L)	粒度與編號 Grit Size & Order No.				適用夾柄代號 HOLDER Order no.
	#250	#400	#700	#1200	
0.3 x 0.3 x 50	CMOr-035	CMB-035	CMY-035	CMR-035	XH-005
★ 0.3 x 0.3 x 50	CMOrS-035	CMBS-035	CMYS-035	CMRS-035	XH-005
0.5 x 0.5 x 50	CMOr-055	CMB-055	CMY-055	CMR-055	XH-007
★ 0.5 x 0.5 x 50	CMOrS-055	CMBS-055	CMYS-055	CMRS-055	XH-007
0.7 x 0.7 x 50	CMOr-075	CMB-075	CMY-075	CMR-075	XH-009
★ 0.7 x 0.7 x 50	CMOrS-075	CMBS-075	CMYS-075	CMRS-075	XH-009
0.9 x 0.9 x 50	CMOr-095	CMB-095	CMY-095	CMR-095	XH-013
★ 0.9 x 0.9 x 50	CMOrS-095	CMBS-095	CMYS-095	CMRS-095	XH-013
1.0 x 2.0 x 100	CMOr-121	CMB-121	CMY-121	CMR-121	XH-200
★ 1.0 x 2.0 x 100	CMOrS-121	CMBS-121	CMYS-121	CMRS-121	XH-200
ø0.9 x 50	CMOr-105	CMB-105	CMY-105	CMR-105	XH-009
ø2.0 x 100	CMOr-201	CMB-201	CMY-201	CMR-201	XH-200

★代表三支組+夾柄

#### 油石子夾柄 / Polishing stone holders:

單位: mm

編號/Order NO.	可夾持尺寸/Holding Capacity	運用/Applications
XH-005	方形/Square 0.3 x 0.3 or 圓/Round ø0.5	迷你纖維油石 For Mini Fiber Stone
XH-007	方形/Square 0.5 x 0.5 or 圓/Round ø0.7	迷你纖維油石 For Mini Fiber Stone
XH-009	方形/Square 0.7 x 0.7 or 圓/Round ø0.9	迷你纖維油石 For Mini Fiber Stone
XH-200	平形/Flat 2 x 1 or 圓/Round ø2.0	迷你纖維油石 For Mini Fiber Stone
XH-013	方形/Square 0.9 x 0.9 or 圓/Round ø1.3	迷你纖維油石 For Mini Fiber Stone
XH-22	圓/Round 3.0	纖維油石 For Fiber Stone
XH-041	平形/Flat 4 x 1	纖維油石 For Fiber Stone
XH-061	平形/Flat 6 x 1	纖維油石 For Fiber Stone
XH-101	平形/Flat 10 x 1	纖維油石 For Fiber Stone
XH-062	平形/Flat 6 x 2~6 x 3	一般油石 For Oil Stone
XH-133	平形/Flat 13 x 3	一般油石 For Oil Stone
XH-136	平形/Flat 13 x 6.3	一般油石 For Oil Stone

\* 以上為訂製品/Above are customized products



## Ceramic Fiber Stone

### JKK 超級纖維油石



#### 粒度與顏色 / Grit size & color code:

粒度 Grit size	#180	#250	#280	#360	#400	#700	#1200
顏色 Color							
	咖啡色 Brown	橘色 Orange	黑色 Black	海軍藍 Navy Blue	藍色 Blue	黃色 Yellow	紅色 Red
代號/Code	<b>C</b>	<b>O</b>	<b>D</b>	<b>N</b>	<b>B</b>	<b>Y</b>	<b>R</b>

#### 規格 / Specifications:



T x W x L (øD x L)	粒度與編號 Grit Size & Order No.						
	#180	#250	#280	#360	#400	#700	#1200
1 x 4 x 100	JKC-1004	JKO-1004	JKD-1004	JKN-1004	JKB-1004	JKY-1004	JKR-1004
1 x 6 x 100	JKC-1006	JKO-1006	JKD-1006	JKN-1006	JKB-1006	JKY-1006	JKR-1006
1x10 x 100	JKC-1010	JKO-1010	JKD-1010	JKN-1010	JKB-1010	JKY-1010	JKR-1010
ø3 x 100	JKC-03	JKO-03	JKD-03	JKN-03	JKB-03	JKY-03	JKR-03

#### 粒度使用建議 / Recommendation:

粒度/Grit size	使用建議/Applications
#180、#250、#280	模具放電加工後之硬化表層去除及機械切削粗糙刀痕之去除 To remove the rough machining surface or hard EDM scale of tool and die steels.
#360、#400	細微加工痕跡之去除及一般拋磨 General lapping of finer surface scratch line of tool & die steels.
#700、#1200	精細研磨或鏡面處理前之拋光 Fine polishing & finishing.
ø3.0mm 圓柱 / round	可搭配磨機當成研磨棒使用(長度勿超過50mm長)，亦可將之磨尖用於細微角落或窄縫處之研磨 It can be used like grinding point(max. length 50mm), or by sharpening it for detail lapping.

\*使用纖維油石時，請將工具與工件成30°~45°，端面研磨效果最佳。

\*In order to reach the best performance, we recommend that the stone should be held up-right, making an angle of approx. 30°~45° to the work-piece.



## Powerful Ceramic Fiber Stone

### LV強力纖維油石



LV 常勝軍強力纖維油石是以最高等級纖維素材製成，纖維的強度比一般的纖維油石約提高一倍，加上快速切削的特性使您的工作效率大幅度的提升。

Lasting stands for high quality fiber stone, making a crystalline structure of the fibers to homogenous and perfect surface treatment, and providing the highest breakpoint due to the high controlled bonding of fibers.

#### 粒度與顏色 / Grit size & color code:

粒度 Grit size	#120	#220	#400	#600	#800	#1000	#1200
顏色 Color							
	綠色 Green	橘色 Orange	海軍藍 Navy Blue	藍色 Blue	黃色 Yellow	木色 Wood	紅色 Red

#### 規格 / Specifications:



T x W x L	粒度與編號 Grit Size & Order No.						
(øD x L)	#120	#220	#400	#600	#800	#1000	#1200
1 x 2 x 100	JLG-1002	JLO-1002	JLB-1002	JLN-1002	JLY-1002	JLW-1002	JLR-1002
1 x 4 x 100	JLG-1004	JLO-1004	JLB-1004	JLN-1004	JLY-1004	JLW-1004	JLR-1004
1 x 6 x 100	JLG-1006	JLO-1006	JLB-1006	JLN-1006	JLY-1006	JLW-1006	JLR-1006
1 x 10 x 100	JLG-1010	JLO-1010	JLB-1010	JLN-1010	JLY-1010	JLW-1010	JLR-1010
1 x 13 x 100	JLG-1013	JLO-1013	JLB-1013	JLN-1013	JLY-1013	JLW-1013	JLR-1013
ø3 x 100	JLG-03	JLO-03	JLB-03	JLN-03	JLY-03	JLW-03	JLR-03



## Electric Grinders

### SUPER-LV350 電動研磨機



#### 特點:

- ▶ 無段式轉速操控裝置，您可自由調整從0到35,000轉。本機可自由設定順時針及逆時針旋轉。
- ▶ 隨機附贈腳踏開關，操控方式更加多元化。

#### Features:

- ▶ Variable speed design allows for speed change from 0 to 35,000 rpm. Also, clockwise and counter-clockwise running direction can be set as desired.
- ▶ Equipped with a foot switch for added convenience of operation.

SUPER-LV350					
Input Power Source	Maximum Load Current	Output Power Source	Fuse	Weight	Dimensions (mm)
AC100-120V 50/60Hz	3A	DC0-32V	2A	1.2kg	W130 L 150 H 84

EPH-LV350								
Non Load Rpm	Weight	Torque	W	Dimensions (mm)				
				L	L1	L2	D	D1
35,000	232g	300 gf.cm	65	159	74	85	28.2	18.9

### SUPER-LV450 電動研磨機



#### 特點:

- ▶ 無段式轉速操控裝置，您可自由調整從 0 到 45,000轉
- ▶ 自動超載負荷偵測裝置及反饋系統，可延長機身壽命
- ▶ 本機可自由設定順時針及逆時針旋轉
- ▶ 加大型腳踏開關，使您操控更容易
- ▶ 超高扭力旋轉手機，切削性效率提升50%

#### Features:

- ▶ Variable speed design allows for speed change from 0 to 45,000 rpm.
- ▶ Automatic load detection device and feedback control greatly extend the machine's service life.
- ▶ Clockwise and counter-clockwise running can be set as desired.
- ▶ Oversized foot switch for added convenience of operation.
- ▶ Ultra-high torque output dramatically increases grinding efficiency by 50%.

SUPER-LV450					
Input Power Source	Maximum Load Current	Output Power Source	Fuse	Weight	Dimensions (mm)
AC100-120V 50/60Hz	3A	DC0-32V	2A	1.8kg	W130 L 152 H 103

EPH-LV450								
Non Load Rpm	Weight	Torque	W	Dimensions (mm)				
				L	L1	L2	D	D1
45,000	240g	450 gf.cm	79	156.8	77.8	79	26.8	19



## Electric Grinders



### SUPER-LV500 電動研磨機

全新無刷式手件，超薄設計，重量輕  
New Brushless Handpiece with super-slim & light design



**特點：**

- ▶ 數字表。
- ▶ 低轉速時具有高扭力輸出。
- ▶ 可立臥放置。

**Features:**

- ▶ Digital watch
- ▶ Strong torque at low speed
- ▶ vertical / Horizontal placement

- ▶ 轉速：最高 50,000 rpm
- ▶ 扭力：7.8 N.cm
- ▶ 輸入：110, 220v
- ▶ 功率輸出：230w
- ▶ 重量：控制箱2.5kg  
手件254g (Super-LV500 Hp)
- ▶ 左右旋轉功能
- ▶ 手控/腳控速度控制系統
- ▶ 自我檢測、異常顯示、工件記憶儲存功能

- ▶ Rpm: Max 50,000 rpm
- ▶ Torque: 7.8 N.cm
- ▶ Input: 110, 220v
- ▶ Output: 230w
- ▶ Weight: Control box 2.5kg  
Hand piece 254g (Super-LV500 Hp)
- ▶ Right & Left turning ability
- ▶ Hand / Foot speed control system
- ▶ Self-diagnosis, Error display, Work memory storage function

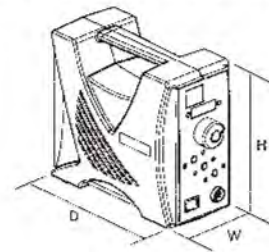

SUPER-LV500 HP						SUPER-LV500 CB									
無負載轉速 NON LOAD RPM	50,000 RPM					型號 CLASSIFICATION	輸入電源 INPUT PWER SOURCE	保險絲 FUSE	重量 WEIGHT	尺寸 DIMENSION (mm)	最大負載電流 MAXIMUM LOAD CURRENT				
功率輸出 OUTPUT	230W														
最大扭力 MAX. TORQUE	7.8 N.cm														
重量 WEIGHT	254g					LV500-110V	AC110V 60Hz	2A	2.5kg	(W) 96 (D) 207 (H) 182	2A				
尺寸 DIMENSIONS	L	L1	L2	D	D1	LV500-220V	AC220V 50Hz	2A							
	171	78	93	27	18										



## Precision Air Grinder

### 氣動工具系列產品

編號/Order No.	<b>LV-370A</b>
轉速/RPM.	70,000
夾頭/Collet chuck	Ø3.0mm(2.34)
空氣壓力/Air pressure	90/psi(maximum)
空氣消耗量/Air consumption	0.08M <sup>3</sup> /Min



**LV-0001 高速型氣動研磨機**  
High Speed Air Grinder

編號/Order No.	<b>AGP-635</b>
轉速/RPM.	35,000
夾頭/Collet chuck	Ø3.0mm/ Ø6.0mm
空氣壓力/Air pressure	90/psi(maximum)
空氣消耗量/Air consumption	0.12M <sup>3</sup> /Min

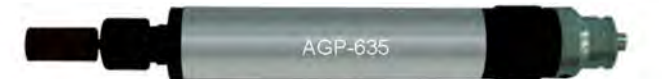

**LV-0002 3-6氣動重型刻磨機**  
3-6 Heavy Type Air Graving Machine

編號/Order No.	<b>MSG-3BSN</b>
轉速/RPM.	65,000
夾頭/Collet chuck	Ø3.0mm
空氣壓力/Air pressure	90/psi(maximum)
空氣消耗量/Air consumption	0.18M <sup>3</sup> /Min



**LV-0003 精密型刻磨機**  
Precision Type Graving Machine

編號/Order No.	<b>MAG-093N</b>
轉速/RPM.	23,500
夾頭/Collet chuck	Ø3.0mm
空氣壓力/Air pressure	90/psi(maximum)
空氣消耗量/Air consumption	0.12M <sup>3</sup> /Min



**LV-0004 平面研磨機(90°)**  
Surface Grinder (90°)

編號/Order No.	<b>MAG-123N</b>
轉速/RPM.	23,500
夾頭/Collet chuck	Ø3.0mm
空氣壓力/Air pressure	90/psi(maximum)
空氣消耗量/Air consumption	0.12M <sup>3</sup> /Min



**LV-0005 平面研磨機(45°)**  
Surface Grinder (45°)

編號/Order No.	<b>MAG-091N</b>
轉速/RPM.	23,500
夾頭/Collet chuck	Ø3.0mm
空氣壓力/Air pressure	90/psi(maximum)
空氣消耗量/Air consumption	0.12M <sup>3</sup> /Min



**LV-0006 內孔研磨機(90°)**  
Internal Grinder (90°)

編號/Order No.	<b>MAG-121N</b>
轉速/RPM.	52,500
夾頭/Collet chuck	Ø3.0mm(2.34)
空氣壓力/Air pressure	90/psi(maximum)
空氣消耗量/Air consumption	0.12M <sup>3</sup> /Min



**LV-0007 內孔研磨機(45°)**  
Internal Grinder (45°)



## Precision Air Grinder

### 氣動工具系列產品

編號/Order No.	<b>LV-03T</b>
轉速/RPM.	55,000
空氣壓力/Air pressure	90/psi(maximum)
空氣消耗量/Air consumption	0.08M <sup>3</sup> /Min



**LV-0008** 0.3mm往復式氣動研磨機  
0.3mm Stroke Air Lapping Machine

編號/Order No.	<b>LV-07T</b>
轉速/RPM.	22,000
空氣壓力/Air pressure	90/psi(maximum)
空氣消耗量/Air consumption	0.08M <sup>3</sup> /Min



**LV-0009** 0.7mm往復式氣動研磨機  
0.7mm Stroke Air Lapping Machine

編號/Order No.	<b>TLL-015T</b>
往復行程/Stroke	REV.0.15(mm)
往復頻率/Frequency	60,000
空氣壓力/Air pressure	90/psi(maximum)
空氣消耗量/Air consumption	0.08M <sup>3</sup> /Min



**LV-0010** 往復式氣動超音波機  
Travel Type Air Ultrasonic Grinder

編號/Order No.	<b>TLL-03T</b>
往復行程/Stroke	REV.0.3(mm)
往復頻率/Frequency	55,000
空氣壓力/Air pressure	90/psi(maximum)
空氣消耗量/Air consumption	0.08M <sup>3</sup> /Min



**LV-0011** 往復式氣動超音波機  
Travel Type Air Ultrasonic Grinder

編號/Order No.	<b>TLL-07T</b>
往復行程/Stroke	REV.0.7(mm)
往復頻率/Frequency	22,000
空氣壓力/Air pressure	90/psi(maximum)
空氣消耗量/Air consumption	0.10M <sup>3</sup> /Min



**LV-0012** 往復式氣動超音波機  
Travel Type Air Ultrasonic Grinder

編號/Order No.	<b>TLL-12T</b>
往復行程/Stroke	REV.1.2(mm)
往復頻率/Frequency	15,000
空氣壓力/Air pressure	90/psi(maximum)
空氣消耗量/Air consumption	0.12M <sup>3</sup> /Min



**LV-0013** 往復式氣動超音波機  
Travel Type Air Ultrasonic Grinder



## Precision Air Grinder

### 氣動工具系列產品

編號/Order No.	<b>AR-05</b>
往復行程/Stroke	0.5(mm)
往復頻率/Frequency	35,000(strokes/min)
空氣壓力/Air pressure	90/psi(maximum)
空氣消耗量/Air consumption	0.05(m <sup>3</sup> /min)



**LV-0014** 活塞式引擎 快速研磨用  
Piston Type Engine Express Grinding Use

編號/Order No.	<b>AR-991</b>
往復行程/Stroke	REV.0~6(mm)
往復頻率/Frequency	4,500(strokes/min)
空氣壓力/Air pressure	90/psi(maximum)
空氣消耗量/Air consumption	0.10(m <sup>3</sup> /min)



**LV-0015** 往復槍研磨機  
Travel Gun Grinder

編號/Order No.	<b>LV-360A</b>
轉速/RPM.	60,000
夾頭/Collet chuck	Ø3.0mm(2.34)
空氣壓力/Air pressure	90/psi(maximum)
空氣消耗量/Air consumption	0.08M <sup>3</sup> /Min



**LV-0016** 高速型氣動研磨機  
High Speed Air Grinder

編號/Order No.	<b>LV-3BSN</b>
轉速/RPM.	65,000
夾頭/Collet chuck	Ø3.0mm
空氣壓力/Air pressure	90/psi(maximum)
空氣消耗量/Air consumption	0.18M <sup>3</sup> /Min



**LV-0017** 精密型氣動研磨機  
Precision Type Air Grinder

編號/Order No.	<b>AR-06</b>
往復行程/Stroke	0.6(mm)
往復頻率/Frequency	22,000(strokes/min)
空氣壓力/Air pressure	90/psi(maximum)
空氣消耗量/Air consumption	0.10(m <sup>3</sup> /min)



**LV-0018** 風葉式引擎 運作穩定  
Fan Type Engine Smooth Operation



## 氣動工具系列產品

### 圓砂布片 Paper Disc & Rubber Pads



自黏圓紗布 $\phi$ 30mm  
用途：配合電動氣動研  
磨工具，各種尺寸、粒  
度均可訂作。

$\phi$ 30mm long lasting, fast cutting durable discs made from quality bonded paper with strong adhesive. 150pcs/set. A disc holder is included. Apply for model 23,500 rpm.

訂購代號/番數：  
1Q / #60, #100, #150, #240, #320, #400, #600



### 日製碗型小砂輪 Grinding Cup Wheels



研磨砂輪 $\phi$ 30mm  
用途：配合手持氣動工具，  
適用於木材上研磨有三種粒  
度選擇。

General applications for grinding and material removal. Ideal for fast rough grinding, smooth shaping and finishing of concrete surface.

訂購代號/番數：  
JEG / #60, #100, #150

### 西德自黏砂紙 Sandpaper Rolls (Self-Adhesive)



性能：  
用於底部加工及難度處  
理之角度，配合平面研  
磨機，氣動銼刀機。

Quality bonded paper roll with strong adhesive. Long lasting, fast cutting.

#### Applications:

- Carbon steel
- Stainless steel
- Alloyed tool steel
- Grey cast iron
- Glass, ceramics, stone
- Thermoplastic, thrmosetting plastic
- Natural wood
- Particleboard, plywood

訂購代號/番數：  
1RV2 / #60, #80, #100, #120, #150, #180, #240, #320, #400, #600, #800, #1000, #1200

## 日本UHT氣動工具系列產品

MSG-3BSN			MAG-121N		
轉速 Free Speed (rpm)	65,000		轉速 Free Speed (rpm)	52,500	
空氣壓力 Air Pressure Recommended (psi)	90		空氣壓力 Air Pressure Recommended (psi)	90	
尺寸 Dimensions $\phi$ DxL (mm)	17x143		尺寸 Dimensions $\phi$ DxL (mm)	17x107	
重量 Weight (g)	130		重量 Weight (g)	140	
夾頭 Chuck Diameter (mm)	$\phi$ 3	夾頭 Chuck Diameter (mm)	$\phi$ 3		
MAG-091N			MAG-122N		
轉速 Free Speed (rpm)	23,500		轉速 Free Speed (rpm)	35,000	
空氣壓力 Air Pressure Recommended (psi)	90		空氣壓力 Air Pressure Recommended (psi)	90	
尺寸 Dimensions $\phi$ DxL (mm)	17x108		尺寸 Dimensions $\phi$ DxL (mm)	17x104	
重量 Weight (g)	140		重量 Weight (g)	130	
夾頭 Chuck Diameter (mm)	$\phi$ 3	夾頭 Chuck Diameter (mm)	$\phi$ 3		
MAG-093N			MAG-123N		
轉速 Free Speed (rpm)	23,500		轉速 Free Speed (rpm)	23,500	
空氣壓力 Air Pressure Recommended (psi)	90		空氣壓力 Air Pressure Recommended (psi)	90	
尺寸 Dimensions $\phi$ DxL (mm)	17x108		尺寸 Dimensions $\phi$ DxL (mm)	17x123	
重量 Weight (g)	140		重量 Weight (g)	175	
夾頭 Chuck Diameter (mm)	$\phi$ 3	夾頭 Chuck Diameter (mm)	$\phi$ 3		

## 精密氣動工具系列產品 Precision Air Grinder

AF-05 往復氣動銼刀機 Recipro Air Lapper			AF-10 往復氣動銼刀機 Recipro Air Lapper		
搖擺頻率 Frequency (stroke/rpm)	3400/min		搖擺頻率 Frequency (stroke/rpm)	3000/min	
空氣壓力 Air Pressure Recommended (psi)	90		空氣壓力 Air Pressure Recommended (psi)	90	
尺寸 Dimensions $\phi$ DxL (mm)	29x163		尺寸 Dimensions $\phi$ DxL (mm)	29x157	
重量 Weight (g)	350		重量 Weight (g)	350	
左右行程 Linear Stroke (mm)	5	左右行程 Linear Stroke (mm)	10		



# UHT Precision Air Grinder



## 日本UHT氣動工具系列產品

往復式圖 Linear Stroke		
<b>TLL-03</b>		
往復頻率 Frequency (stroke/rpm)	52,000	
空氣壓力 Air Pressure Recommended (psi)	90	
尺寸 Dimensions $\Phi$ DxL (mm)	28x218	
重量 Weight (g)	180	
往復行程 Linear Stroke (mm)	0.3	
<b>TLL-07</b>		
往復頻率 Frequency (stroke/rpm)	28,000	
空氣壓力 Air Pressure Recommended (psi)	90	
尺寸 Dimensions $\Phi$ DxL (mm)	28x218	
重量 Weight (g)	180	
往復行程 Linear Stroke (mm)	0.7	
<b>TLL-12</b>		
往復頻率 Frequency (stroke/rpm)	19,000	
空氣壓力 Air Pressure Recommended (psi)	90	
尺寸 Dimensions $\Phi$ DxL (mm)	28x218	
重量 Weight (g)	180	
往復行程 Linear Stroke (mm)	1.2	

搖擺式圖 Swing Stroke		
<b>TLS-03</b>		
往復搖擺頻率 Frequency (stroke/rpm)	56,000	
空氣壓力 Air Pressure Recommended (psi)	90	
尺寸 Dimensions $\Phi$ DxL (mm)	28x218	
重量 Weight (g)	180	
左右行程 Linear Stroke (mm)	0.3x6.2	
<b>TLS-07</b>		
往復搖擺頻率 Frequency (stroke/rpm)	20,000	
空氣壓力 Air Pressure Recommended (psi)	90	
尺寸 Dimensions $\Phi$ DxL (mm)	28x218	
重量 Weight (g)	180	
左右行程 Linear Stroke (mm)	0.7x9	
<b>TLS-12</b>		
往復搖擺頻率 Frequency (stroke/rpm)	14,000	
空氣壓力 Air Pressure Recommended (psi)	90	
尺寸 Dimensions $\Phi$ DxL (mm)	28x218	
重量 Weight (g)	180	
左右行程 Linear Stroke (mm)	1.2x12	



## 精密氣動工具系列產品 Precision Air Grinder

SM-15 靜音平面散打機 Silent Air Finger Sander		
搖擺頻率 Frequency (stroke/rpm)	15,000	
空氣壓力 Air Pressure Recommended (psi)	90	
尺寸 Dimensions $\Phi$ DxL (mm)	38x95x190	
重量 Weight (g)	750	
往復行程 Linear Stroke (mm)	1.5	

SM-30 靜音平面散打機 Silent Air Finger Sander		
搖擺頻率 Frequency (stroke/rpm)	15,000	
空氣壓力 Air Pressure Recommended (psi)	90	
尺寸 Dimensions $\Phi$ DxL (mm)	38x95x190	
重量 Weight (g)	750	
往復行程 Linear Stroke (mm)	3.0	



# TZF

## 精密平斜鑽石鏢刀組 Diamond Needle Taper Files



**SE-12**  
170L x 50B x 3.0Sh

12  
PVC套裝12支組  
12Pcs / Set / PVC Pouch

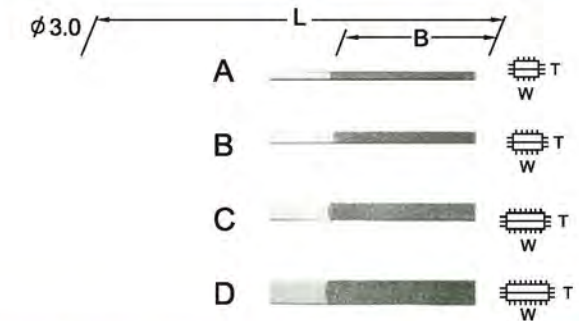

形狀 Shape	全長 L	鑽石長度 B	寬度 W	厚度 T	柄徑 Shank	粒度 Grit	訂購代號 Order No
A	170	50	3	0.4 ~ 1.5	3 x 1.5	#120	SE-03-120
						#200	SE-03-200
						#400	SE-03-400
B			4	0.5 ~ 2.0	4 x 2.0	#120	SE-04-120
						#200	SE-04-200
						#400	SE-04-400
C			6	0.5 ~ 2.0	6 x 2.0	#120	SE-06-120
						#200	SE-06-200
						#400	SE-06-400
D			8	0.5 ~ 2.5	8 x 2.5	#120	SE-08-120
						#200	SE-08-200
						#400	SE-08-400

12支組裝 / 12PCS / SET

SE-12



# TZF

## 精密平斜鑽石鏢刀組 Diamond Needle Taper Files



**SG-10**  
130L x 30B x 3.0Sh

10  
PVC套裝10支組  
10Pcs / Set / PVC Pouch

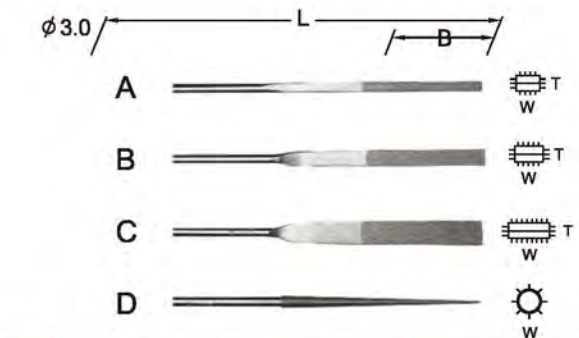

形狀 Shape	全長 L	鑽石長度 B	寬度 W	厚度 T	柄徑 Shank	粒度 Grit	訂購代號 Order No		
A	130	30	2	0.4 ~ 1.7	3	#200	SG-32-200		
						#400	SG-32-400		
						#600	SG-32-600		
B			4			#200	SG-34-200		
							#400	SG-34-400	
							#600	SG-34-600	
C			6			#200	SG-36-200		
							#400	SG-36-400	
							#600	SG-36-600	
D			3			50	-	#400	SP-103-400

10支組裝 / 10PCS / SET

SG-10



# TZF

## 機械用平斜鑽石銼刀 Mechanical Taper Diamond Files



### SG-MA12

80L x 25B x 3.0Sh

12

PVC套裝12支組  
12Pcs / Set / PVC Pouch

說明:

- 1.此型平斜短銼台金質量佳、尺寸準、厚度薄、角度直。
- 2.鑽石表面平整不重疊。
- 3.專用於電動式超音波拋光機及氣動往覆機上，使用效果特佳。

Features:

1. Quality short files, precision sizes, fine thinness, and straight angles.
2. Smooth diamond face.
3. Suitable for electric type ultrasonic lapping machine and air travel grinder, with excellent effects.

形狀 Shape	全長 L	鑽石長度 B	寬度 W	厚度 T	柄徑 Shank	粒度 Grit	訂購代號 Order No								
A	80	25	2	0.5~1.4	3	#120	SG-MA02-120								
						#200	SG-MA02-200								
						#400	SG-MA02-400								
						#600	SG-MA02-600								
B			80			25	4	0.5~1.4	3	#120	SG-MA04-120				
										#200	SG-MA04-200				
										#400	SG-MA04-400				
										#600	SG-MA04-600				
C							80			25	6	0.5~1.4	3	#120	SG-MA06-120
														#200	SG-MA06-200
														#400	SG-MA06-400
														#600	SG-MA06-600
12支組套裝 / 12PCS / SET											SG-MA12				



# TZF

## 異型鑽石銼刀 Profiled Diamond Files



### BF-L05

140L x 20~30B x 3.0Sh

5

PVC套裝5支組  
5Pcs / Set / PVC Pouch



形狀 Shape	全長 L	鑽石長度 B	寬度 W	厚度 T	柄徑 Shank	粒度 Grit	訂購代號 Order No
A	140	20~30	6	1.5	3	#150	BF11-Grit
B			5	2			BF12-Grit
C			3.5	3.5			BF13-Grit
D			2.5	2.5			BF14-Grit
E			3	3			BF15-Grit
5支組裝 / 5PCS / SET (以上型號同粒度各1支)							BF-L05



# TZF

## 機械用異型鑽石銼刀組 Mechanical Profiled Diamond Files



### MF-10

65L x 20~30B x 3.0Sh

10

PVC套裝10支組  
10Pcs / Set / PVC Pouch

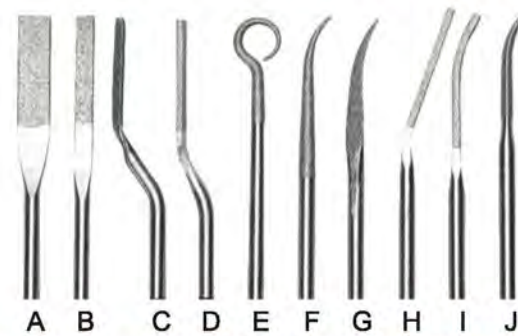

形狀 Shape	全長 L	鑽石長度 B	寬度 W	厚度 T	柄徑 Shank	粒度 Grit	訂購代號 Order No	
A	65	20	5.8	1.2	3	#150	MF-11-Grit	
B			1.4	3.2			MF-12-Grit	
C			5	2			MF-13-Grit	
D			3.2	1.4			MF-14-Grit	
E			3	3			MF-15-Grit	
F		30	3	3			MF-16-Grit	
G			3	3			MF-17-Grit	
H			20	3.2			1.4	MF-18-Grit
I				3.2			1.4	MF-19-Grit
J				4			2	MF-20-Grit
10支組裝 / 10PCS / SET (以上型號同粒度各1支)							MF-10	



# TZF

## 異型鑽石雙頭銼刀組 Profiled Diamond Double-End Files



### BFD-05

150L x 20~25B x 3.0Sh

5

PVC套裝5支組  
5Pcs / Set / PVC Pouch



形狀 Shape	全長 L	鑽石長度 B	寬度 W	厚度 T	柄徑 Shank	粒度 Grit	訂購代號 Order No	
A	150	20~25	25	3	3	#120	BFD01-Grit	
B			25	2			2	BFD02-Grit
C			20	2			2	BFD03-Grit
D			25	3			3	BFD04-1-Grit
E			20	2.5			2.5	BFD05-1-Grit
5支組裝 / 5PCS / SET (以上型號同粒度各1支)							BFD-05	



# TZF

## 異型鑽石銼刀 Profiled Diamond Files



### BF-10

140L x 20~30 B x 3.0Sh

10  
PVC套裝10支組  
10Pcs / Set / PVC Pouch



形狀 Shape	全長 L	鑽石長度 B	寬度 W	厚度 T	柄徑 Shank	粒度 Grit	訂購代號 Order No
A	140	20~30	5	1.2	3	#120 #200 #400	BF01-Grit
B			2	2			BF02-Grit
C			4	2			BF03-Grit
D			3	3			BF04-Grit
E			2.5	2.5			BF05-Grit
F			3	1.2			BF06-Grit
G			2	2			BF07-Grit
H			6	1.2			BF08-Grit
I			5	1.6			BF09-Grit
J			3	1.2			BF10-Grit

10支組裝 / 10PCS / SET (以上型號同粒度各1支)

BF-10



# TZF

## 平型鑽石銼刀組 Flat Diamond Files



### SF-05

140L x 50B x 3.0Sh

4  
PVC套裝4支組  
4Pcs / Set / PVC Pouch

正面  
FACE



側面  
SIDE



形狀 Shape	全長 L	鑽石長度 B	寬度 W	厚度 T	柄徑 Shank	粒度 Grit	訂購代號 Order No
A	140	40	5.5	0.5	3	#140 #200 #400	SF01-Grit
B		50		0.8			SF02-Grit
C		50		1.0			SF03-Grit
D		50		1.2			SF04-Grit

4支組裝 / 4PCS / SET (以上型號同粒度各1支)

SF-05



# TZF

## 精密鑽石銼刀 Needle Diamond Files



### SP-L05

200L x 80B x 4.0Sh

5  
PVC套裝5支組  
5Pcs / Set / PVC Pouch



形狀 Shape	全長 L	鑽石長度 B	寬度 W	厚度 T	柄徑 Shank	粒度 Grit	訂購代號 Order No
A	200	80	8.5	1.6	4	#120 #200	SP051-Grit
B			7	2.5			SP052-Grit
C			4	4			SP053-Grit
D			5	5			SP054-Grit
E			3.4	3.5			SP055-Grit

5支組裝 / 5PCS / SET (以上型號同粒度各1支)

SP-L05



# TZF

## 精密鑽石銼刀 Needle Diamond Files



### SP-ML07

180L x 70B x 3.5Sh

5  
PVC套裝5支組  
5Pcs / Set / PVC Pouch



形狀 Shape	全長 L	鑽石長度 B	寬度 W	厚度 T	柄徑 Shank	粒度 Grit	訂購代號 Order No
A	180	70	7.5	1.5	3.5	#120 #200	SP071-Grit
B			6	2.1			SP072-Grit
C			3.5	3.5			SP073-Grit
D			4	4			SP074-Grit
E			3.4	3.4			SP075-Grit

5支組裝 / 5PCS / SET (以上型號同粒度各1支)

SP-ML07



**TZF**

**鐵工鑽石銼刀**  
*Needle Diamond Files*



**IP-L05**

215L x 80T x W

5

PVC套裝5支組  
5Pcs / Set / PVC Pouch

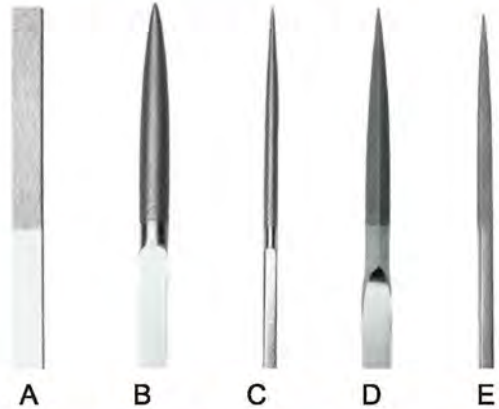

形狀 Shape	全長 L	鑽石長度 B	寬度 W	厚度 T	柄徑 Shank	粒度 Grit	訂購代號 Order No
A	215	80	11	3.5	10.5 x 3	#100	IP051
B			10.5	4.4	10.5 x 3		IP052
C			5	5	5 x 5		IP053
D			7.7	7.7	10.5 x 3		IP054
E			6.3	6.3	5 x 5		IP055
5支組裝 / 5PCS / SET (以上型號同粒度各1支)							IP-L05



**TZF**

**精密鑽石銼刀**  
*Needle Diamond Files*



**SP-SL10**

140L x 50T x 3.0B

10

PVC套裝10支組  
10Pcs / Set / PVC Pouch



形狀 Shape	全長 L	鑽石長度 B	寬度 W	厚度 T	柄徑 Shank	粒度 Grit	訂購代號 Order No
A	140	50	6	1.5	3	#120 #200 #400	SP101-Grit
B			5	2			SP102-Grit
C			3	3			SP103-Grit
D			3.5	3.5			SP104-Grit
E			2.5	2.5			SP105-Grit
F			6	1.5			SP106-Grit
G			5.5	1.3			SP107-Grit
H			6	1.5			SP108-Grit
I			5	2			SP109-Grit
J			5	2.2			SP110-Grit
10支組裝 / 10PCS / SET (以上型號同粒度各1支)							SP-SL10



**TZF**

**鐵工鑽石銼刀**  
*Needle Diamond Files*



**IP-M07**

200L x 70T x W

5

PVC套裝5支組  
5Pcs / Set / PVC Pouch

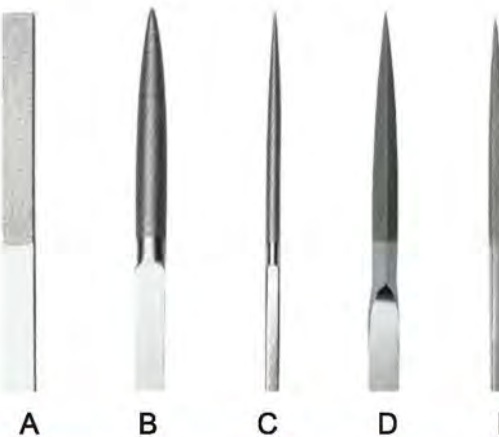

形狀 Shape	全長 L	鑽石長度 B	寬度 W	厚度 T	柄徑 Shank	粒度 Grit	訂購代號 Order No
A	200	70	8.7	3.3	10.5 x 3	#100	IP071
B			8.5	3.1	10.5 x 3		IP072
C			4.7	4.7	5 x 5		IP073
D			6.7	6.7	10.5 x 3		IP074
E			4.5	4.5	5 x 5		IP075
5支組裝 / 5PCS / SET (以上型號同粒度各1支)							IP-M07





**TZF**

**精密鑽石通孔磨鏢刀**  
*Diamond Perforate Taper Files*



**TZF**

**鑽石及氮化硼 (CBN) 內孔研磨輪**  
*Diamond & CBN Mounted*



**FSD 標準型鑽石穿孔磨鏢刀**  
*Standardized Diamond Perforate Taper Files*

D x 80T x 140L

說明：  
1.此磨鏢為鑄鋼眼模通孔，定尺寸標準用。  
2.外徑尺寸每0.1mm為一標準規格。

Features:

1. This taper file is used for the perforation of tungsten steel eye molds and the setting of standardized size.
2. Each 0.1mm external diameter is a standard specification.

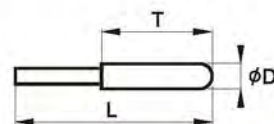

外徑 ØD	全長 L	鑽石長度 T	粒度 Grit	訂購代號 Order No
1.0	140	80	#100	FSD-1.0
1.1				FSD-1.1
1.2				FSD-1.2
1.3				FSD-1.3
1.4				FSD-1.4
1.5				FSD-1.5



**FLD 加長型鑽石穿孔磨鏢刀**  
*Lengthen Diamond Perforate Taper Files*

D x 120T x 200~250L

說明：  
1.此磨鏢為鑄鋼眼模通孔，定尺寸標準用。  
2.外徑尺寸每0.1mm為一標準規格。

Features:

1. This taper file is used for the perforation of tungsten steel eye molds and the setting of standardized size.
2. Each 0.1mm external diameter is a standard specification.

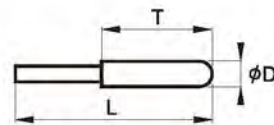

外徑 ØD	全長 L	鑽石長度 T	粒度 Grit	訂購代號 Order No
1.6~5.0	200	120	#100	FLD-(1.6~5.0)
5.1~6.0				FLD-(5.1~6.0)
6.1~7.0				FLD-(6.1~7.0)

外徑 ØD	全長 L	鑽石長度 T	粒度 Grit	訂購代號 Order No
7.1~8.0	250	120	#100	FLD-(7.1~8.0)
8.1~9.0				FLD-(8.1~9.0)
9.1~10.0				FLD-(9.1~10.0)

訂購範例：FLD-250-75-100  
型號 總長 (7.5OD) 粒度

Order Ex. : FLD-250-75-100  
Model L (7.5OD) Grit

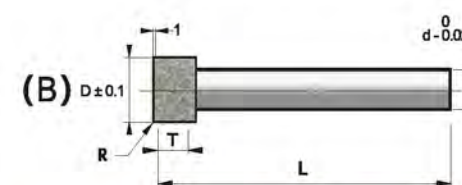
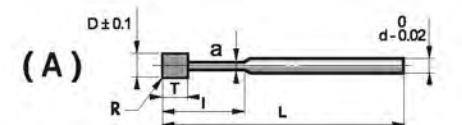

材質 柄徑3mm SKD11  
柄徑6mm SUJ-2



外徑 D	粒度 Grit	形狀 Shape	厚度 T	端部 R	頸徑 a	頸長 l	柄徑 d	全長 L	訂購編號 Order No	
									鑽石SDC	氮化硼CBN
0.4	400	A	2	(0.08)	(0.32)	5	3	35	MMD-3004	MMB-3004
0.5	400	A	2	(0.08)	(0.42)	5	3	35	MMD-3005	MMB-3005
0.6	200	A	3	(0.18)	(0.42)	5	3	40	MMD-3006	MMB-3006
0.7	200	A	3	(0.18)	(0.52)	8	3	40	MMD-3007	MMB-3007
0.8	200	A	3	(0.18)	(0.62)	8	3	40	MMD-3008	MMB-3008
0.9	200	A	4	(0.18)	(0.72)	8	3	40	MMD-3009	MMB-3009
1	200	A	5	(0.18)	(0.82)	8	3	40	MMD-3010	MMB-3010
1.2	200	A	5	(0.18)	(1.02)	8	3	45	MMD-3012	MMB-3012
1.3	200	A	5	(0.18)	(1.12)	8	3	45	MMD-3013	MMB-3013
1.5	150	A	5	(0.18)	(1.32)	8	3	45	MMD-3015	MMB-3015
1.7	150	A	5	(0.18)	(1.52)	8	3	45	MMD-3017	MMB-3017
2	150	A	5	(0.18)	(1.82)	12	3	45	MMD-3020	MMB-3020
2.3	150	A	5	(0.18)	(2.12)	12	3	45	MMD-3023	MMB-3023
2.5	150	A	5	(0.3)	(2.2)	15	3	45	MMD-3025	MMB-3025
3	150	A	5	(0.3)	(2.7)	15	3	45	MMD-3030	MMB-3030
3.5	150	A	5	(0.3)	-	-	3	45	MMD-3035	MMB-3035
4	150	A	5	(0.3)	-	-	3	50	MMD-3040	MMB-3040
4.5	150	A	5	(0.3)	-	-	3	50	MMD-3045	MMB-3045
5	150	A	8	(0.3)	-	-	3	50	MMD-3050	MMB-3050
6	150	A	8	(0.3)	-	-	3	50	MMD-3060	MMB-3060
7	100	B	10	(0.3)	-	-	6	80	MMD-6070	MMB-6070
8	100	B	10	(0.3)	-	-	6	80	MMD-6080	MMB-6080
9	100	B	10	(0.3)	-	-	6	80	MMD-6090	MMB-6090
10	100	B	10	(0.3)	-	-	6	80	MMD-6100	MMB-6100
12	100	B	10	(0.3)	-	-	6	80	MMD-6120	MMB-6120
15	100	B	10	(0.3)	-	-	6	80	MMD-6150	MMB-6150

■ 粒度選定標準：1) 粗加工用 #100 2) 半精加工 #150 #200 3) 精加工 #400



**TZF**

**鑽石磨棒系列**  
*Diamond & CBN Mounted Points*

標準柄長3mm 總長45mm / 3mm Shank Diameter Total Length 45mm

圖型 Form																								
編號 Order No.	TA10	TA15	TA20	TA25	TA30	TA35	TA40	TA50	TA60	TA70	TA80	TB10	TB15	TB20	TB25	TB30	TB35	TB40	TB50	TB60	TF20	TF30	TF60	
直徑 D Ø	1	1.5	2	2.5	3	3.5	4	5	6	7	8	1	1.5	2	2.5	3	3.5	4	5	6	2	3	6	
鑽石長 T	7	10	10	10	10	10	10	10	10	10	10	7	10	10	10	10	10	10	10	10	10	10	15	

圖型 Form																									
編號 Order No.	TC20	TC30	TC31	TC40	TC50	TC51	TC60	TC61	TC70	TD10	TD15	TD20	TD25	TD30	TD35	TD40	TD50	TD60	TD80	TQ30	TQ40	TQ50	TQ51	TQ60	TQ61
直徑 D Ø	2	3	3.3	4	5	5	6	6	7	1	1.5	2	2.5	3	3.5	4	5	6	8	3	4	5	5	6	6
鑽石長 T	12	10	15	10	10	12	10	12	10	1	1.5	2	2.5	3	3.5	4	5	6	8	5	6.5	8	12	10	12

圖型 Form																								
編號 Order No.	TG30	TG31	TG40	TG50	TG60	TM40	TM50	TM60	TM80	TP15	TP20	TP30	TP60	TW40	TW50	TW60	TW80	TH25	TH30	TH31	TH35	TH40	TH60	
直徑 D Ø	3	3	4	5	6	4	5	6	8	3°	7°	10°	26°	4	5	6	8	2.5	3	3	3.5	4	6	
鑽石長 T	10	15	10	12	13	1.5	2	3.5	4.5	10	12	15	13	1.5	2	3.5	4.5	8	5	10	8	8	10	

圖型 Form													圖型 Form												
編號 Order No.	TR15	TR20	TR30	TR31	TS15	TS20	TS21	TS30	TS31	TS40	TS50	TS60	TN30	TZ01	TZ02	TZ03	TZ06	TZ15	TZ16	TZ17	TP25	TP35			
直徑 D Ø	1.5	2	3	3	1.5	2	2.1	3	3	4	5	6	3	3	3	3	2	2	2	2.3	2.5	3			
鑽石長 T	10	12	15	15	3	4	6	5	6	7	9	10	5	40	40	40	40	35	30	45	35	35			
全長 L													80	80	80	70	80	70	70	65	65				

**TZF-30 鑽石磨棒組 (30支裝) / Mounted Point Set (30pcs/set)**

編號 Order No.	TZ30																																
		TA	TA	TA	TA	TA	TA	TA	TA	TA	TA	TB	TB	TB	TB	TB	TB	TB	TD	TD	TD	TD	TD	TD	TF	TF	TG	TG	TP	TP	TP	TR	TR
		10	15	20	25	30	35	40	50	10	15	20	25	30	35	40	50	15	20	30	40	50	20	30	60	40	20	30	15	20	30		



**TZF**

**鑽石磨棒系列**  
*Diamond & CBN Mounted Points*

標準柄長3mm 總長45mm / 3mm Shank Diameter Total Length 45mm

圖型 Form															
編號 Order No.	TT10	TT15	TT20	LTT10	LTT15	LTT20	LTT25	LTT30	LTT35	LTT40	LTT45	LTV15	LTV20	TTV10	
直徑 D Ø	6	6	6	13	13	13	13	13	13	13	13	13	13	6	
鑽石長 T	1	1.5	2	1	1.5	2	2.5	3	3.5	4	4.5	1.5	2	1	

圖型 Form														
編號 Order No.	TTR10	TTR15	TTR20	TTR30	TTR40	LTR10	LTR15	LTR20	LTR25	LTR30	LTR35	LTR40	LTR45	
直徑 D Ø	6	6	6	6	6	13	13	13	13	13	13	13	13	
鑽石長 T	1	1.5	2	3	4	1	1.5	2	2.5	3	3.5	4	4.5	

**內孔研磨棒 & 6mm柄異型磨棒**

圖型 Form				圖型 Form											
編號 Order No.	TTV15	TTV20	TTV10	編號 Order No.	Ig21	Ig22	Ig23	Ig24	Ig25	Ig26	Ig27	Ig28	Ig29	Ig30	IG04-IG12
直徑 D Ø	13	13	6	直徑 D Ø	10°	6.5	8	30°	10	6.5	20°	8	8	8	4~16
鑽石長 T	1.5	2	1	鑽石長 T	25	22	15	15	1.2	15	5	15	8	15	10

**鑽石雕刻針 Diamond Engraving Burrs**

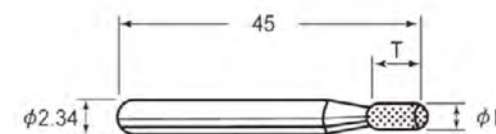

圖型 Form										
編號 Order No.	LA60	LA61	LA62	LA63	LA64	LA65	LA66	LA67	LA68	LA69
直徑 D Ø	16	6	7	3	2.5	2.5	2.5	2.5	1.5	2
鑽石長 T	0.5	10	14	15	10	12	6	45°	10	2

圖型 Form																					
編號 Order No.	LA01	LA02	LA03	LA04	LA05	LA06	LA07	LA08	LA09	LA10	LA11	LA12	LA13	LA14	LA15	LA16	LA16	LA18	LA19	LA20	
直徑 D Ø	1.1	1.4	1.9	2.4	2.7	3.2	1.4	1.9	1.8	2.4	2	2.4	3.5	4.4	1.9	2.6	3.4	3	1.7	4.2	
鑽石長 T	7	7	7	7	7	7	7	7	7	10	12	2	2.4	3.5	7	7	7	7	45°	10	6



**TZF**

**超級磨料種類**  
*Kind of Super Abrasive*

**適用鑽石 With Diamond**

碳化鎢、陶瓷工件、石材、寶石、貝殼、玻璃、石英、耐火磚、氧化鐵、石墨、石棉來令片、矽等堅硬物  
Tungsten carbide, ceramic materials, stones, gems and semi-precious stones, glass, quartz, refoactory, ferrite, graphite, carbon asbestos, silicon, etc.

**適用氮化硼 With CBN**

SKH (高速鋼)、SKS (合金工具鋼)、SK、SKC、SUP等刀具、模具鋼、SKD、SKT、SCM、SNCM、SCR、SUJ、SUS、等鋼材 SUH、SUM 鈦等耐熱金屬  
High alloy steels, high speed tool steels, tempering steels, ball bearing steels, spring steels, cast iron, etc.

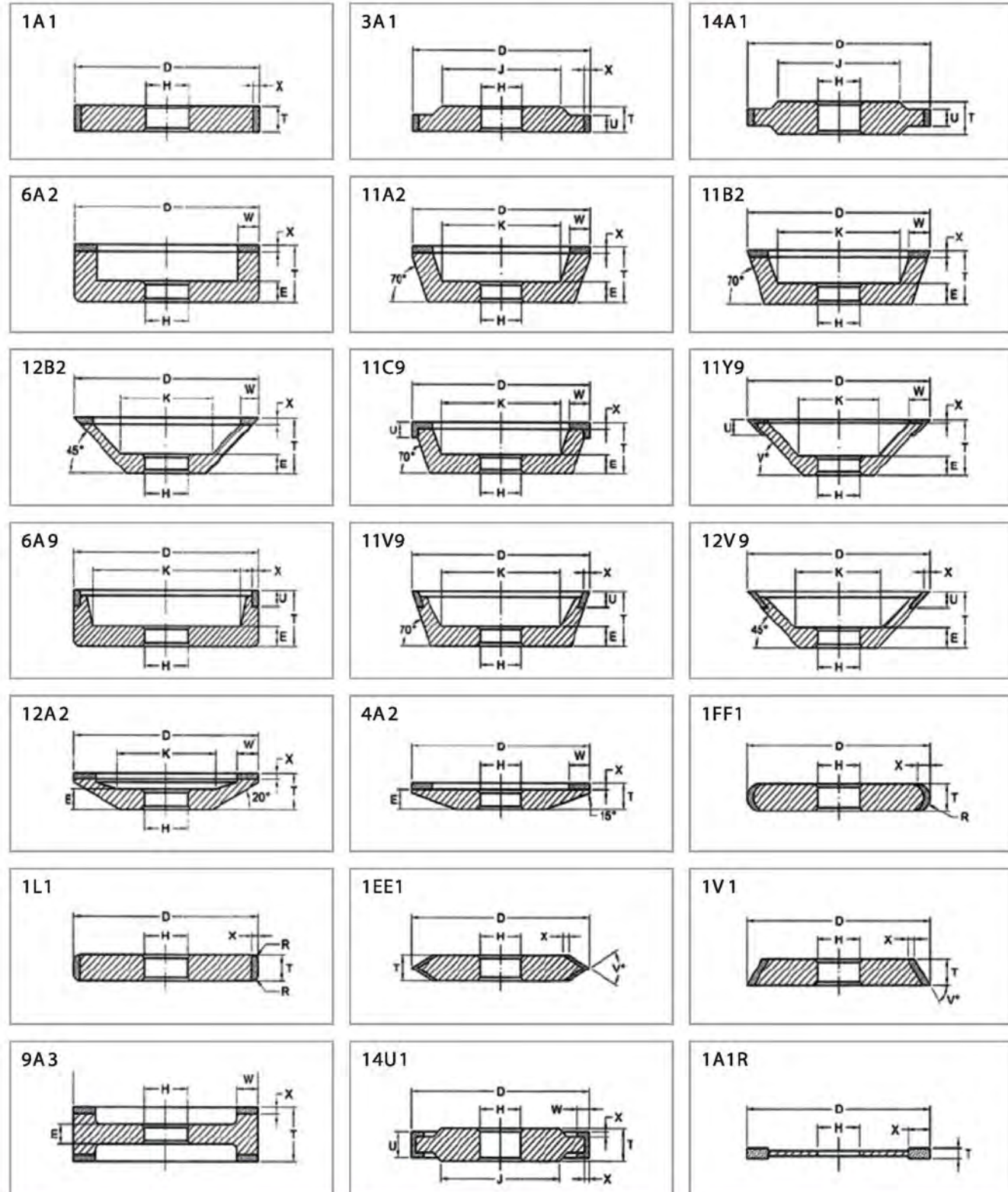

**TZF**

*Cutting Data of Wheels*

**超級磨料砂輪使用轉速參考表**

外徑 D		75	100	125	150	175	200	250	300
砂輪轉速	電鍍法 (P)	6800	5100	4100	3400	2900	2500	2000	1700
Grinding Speed (R.P.M)	樹脂燒結法 (B) 乾 (DRY)	4200	3200	2500	2100	1800	1600	1300	1200
	濕 (WET)	6800	5100	4100	3400	2900	2500	2000	1700

**常用電鍍鑽石、CBN 砂輪**  
*Electroplated Diamond & CBN Wheels*

編號 Order No.	D	T	W	H	U	粒度 Grit size
TZF-001	100	22	10	20	5	#100/200/400
TZF-002	100	35	10	20	5	#100/200/400
TZF-003	150	25	1	25.4		#60/80/100
TZF-004	150	25	5	16		#60/80/100
TZF-005	150	10	5	12.70	6	#200/400
TZF-006	150	10	5	15.88	6	#200/400
TZF-007	150	10	5	12.70	6	#200/400
TZF-008	150	10	5	15.88	6	#200/400
TZF-009	150	6	5	31.75	3	#100/200/400
TZF-010	150	6	5	15.88	3	#100/200/400
TZF-011	150	10	5	31.75		#100/200/400
TZF-012	150	10	5	15.88		#100/200/400
TZF-013	150	10	5	12.70		#100/200/400

**常用樹脂鑽石、CBN 砂輪**  
*Resinoid Diamond & CBN Wheels*

編號 Order No.	D	W	X	T	H	粒度 Grit size
DTI-001	100	8	2	40	20	SDC-150
DTI-002	100	10	2	30	20	SDC-200
DTI-003	100	10	2	30	19.05	SDC-200
DTI-004	150	6	3	10	31.75	SDC-150
DTI-005	175	6	3	10	31.75	SDC-150
DTI-006	100	8	1	5	40	20 SDC-150
DTI-007	125	8	1	5	16	25 60° SDC-400
DTI-008	125	8	1	5	15	25 45° SDC-600
DTI-009	150	25	10	2	36	SDC-400







# 鑽石修刀 Diamond Dressers Tools

## 單石修刀 Single Point Diamond Dressers

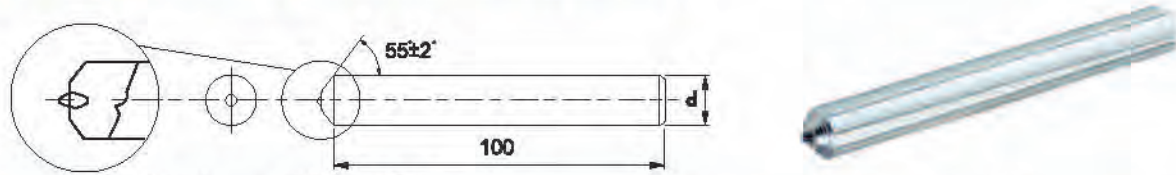

■材質 柄 SK4 頂端 天然鑽石

鑽石番號 Dia. wt. code	大約重量 (克拉) Approx. wt.(cts)	適用砂輪 Grinding wheels size (mm)	訂購代號 Order No.	柄徑 Shank
#2	0.10 cts	Ø150 x 25以下 or smaller	SDD-002	Ø10X80L (A)
#3	0.12 cts		SDD-003	
#4	0.15 cts		SDD-004	
#5	0.18 cts		SDD-005	
#10	0.20 cts		SDD-010	
#15	0.25 cts	Ø150 ~ Ø300 x 25	SDD-015	Ø12X100L (B)
#20	0.35 cts		SDD-020	
#25	0.50 cts		SDD-025	
#33	0.75 cts		SDD-033	
#50	1.0 cts		SDD-050	
#75	1.5 cts	Ø450 ~ Ø600 x 50 ~ 100	SDD-075	
#100	2.0 cts	Ø600以上 / or larger	SDD-100	

訂購代號: SDD-002 (A)或(B) Order Ex: SDD-002(A)or(B)

### 安裝及使用 / Installation and Operation

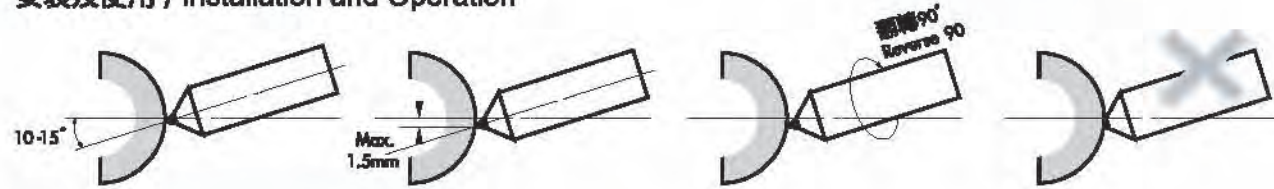

## 圓錐修刀 Coned Diamond Dressers

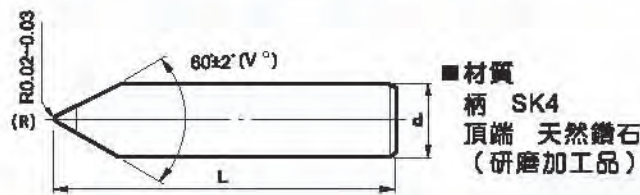

■材質 柄 SK4 頂端 天然鑽石 (研磨加工品)



單位 (Unit): mm

鑽石角度(V°)	鑽石端弧度(R)	柄徑(d)*全長(L)	訂購代號 Order No.
60°	0.02~0.03R	3.175*25.4	CDD-001
60°	0.02~0.03R	3.175*50	CDD-002
60°	0.02~0.03R	6.35*50	CDD-003
60°	0.02~0.03R	9.53*50	CDD-004
60°	0.02~0.03R	10*50	CDD-005



# 鑽石修刀 Diamond Dressers Tools

## 結合修刀 Impregnated Diamond Dressers

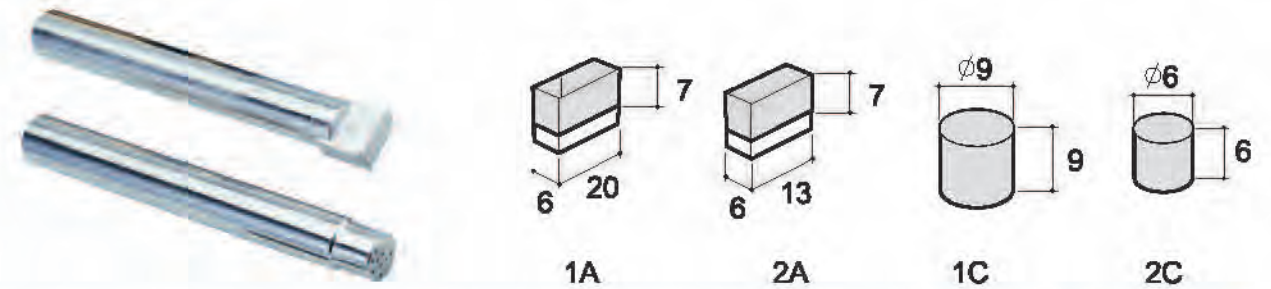

鑲柄形狀 Type of shank	鑲柄尺寸 Size of shank	適用範圍 Applications	鑽石齒塊 Diamond tips	粒度 Grit Size	訂購代號 Order No.
	Ø12 x 100L Ø12 x 50L	無心研磨・圓筒研磨・平面研磨 砂輪尺寸Ø300x25~Ø500x63 For centerless, cylindrical, surface grinding. Wheel size: Ø300x25 to Ø500x63	2A	F	IDD-2AFC
			2A	M	IDD-2AMC
			2A	R	IDD-2ARC
			2A	F	IDD-2AFD
			2A	M	IDD-2AMD
	Ø12 x 50L	一般用途之研磨 砂輪尺寸Ø300或以下 For general purpose grinding Wheel size: Ø300 and smaller.	1C	F	IDD-1CFG
			1C	M	IDD-1CMG
			1C	R	IDD-1CRG

■粒度/ Grit size: • F: 細目/Fine • M: 中目/Medium • R: 粗目/Coarse

## 手持式鑽石修刀 Hand Diamond Dressers



型式 Form	鑽石齒塊 Diamond tips	粒度 Grit Size	訂購代號 Order No.
Type 01  總長/Total length: 160mm		R: 粗目/Coarse F: 細目/Fine	HDD-01R HDD-01F
Type 02  總長/Total length: 200mm 方向① Direction ① 或 Direction ②		R: 粗目/Coarse F: 細目/Fine	HDD-02R HDD-02F



# 鑽石油石 Diamond Polishing Stones

## 鑽石油石 Diamond Polishing Stones

鑽石油石主要使用各種刀具研磨後之刃部修磨，以延長刀具之壽命及提高加工物之表面光潔度。

此外，亦適用於鑄鋼、陶瓷及硬化鋼料之表面研磨。

Diamond polishing stone is considered as a final finish for cutting tools. It is used to refine a surface by removing scratch lines and other surface imperfections, therefore prolonging the tool's life and providing a smooth surface finish.

Also applied to lap the tungsten ceramics and hardened steels.

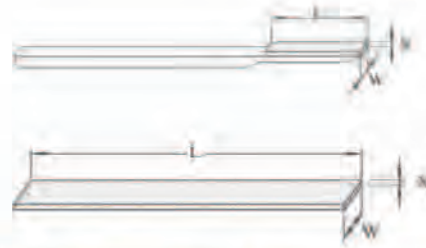

形狀 Shape	尺寸 W-(R)-X-L Dimensions	柄部材質 Shank Material	訂購編號 Order No.
	10 - 2 - 40	塑膠柄 Plastic shank	DP-01-粒度(GRIT)
	5 - 2 - 40	鐵柄 Steel shank	DP-02-粒度(GRIT)
	5 x (R) x 4 x 40	鐵柄 Steel shank	DP-03-粒度(GRIT)
	10 x 2 x 30	鋁柄 Aluminum shank	DP-04-粒度(GRIT)
	10 - 3 - 120	-----	DP-05-粒度(GRIT)
	6 - 3 - 100	-----	DP-06-粒度(GRIT)
	4 - 4 - 100	-----	DP-07-粒度(GRIT)
	13 - 3 - 100	-----	DP-08-粒度(GRIT)
	6 - 2 - 100	-----	DP-09-粒度(GRIT)

說明：1.標準粒度:#100、#200、#400、#600、#800、#1000、#1200、#1800、#2000、#3000、#5000。

2.訂購時，敬請指明產品編號與所需粒度。

Remark: 1.Grit size available:#100、#200、#400、#600、#800、#1000、#1200、#1800、#2000、#3000、#5000。

2.When ordering, please specify order no. & grit size.

## 鑽石砂布 Diamond Polishing Foils

鑽石砂布是以銅箔為基材，電鍍上一層鑽石粉，鑽石磨料佈滿整個銅箔表面。其特色為有較長之工具壽命，可以用刀片自行裁剪成所需尺寸及形狀，然後黏貼在各種工具上，成為您所需的自製工具。其優異的切削效果及多種粒度可供選擇，適合各種模具、鑄鋼、硬陶瓷、石材、玻璃等之研磨及拋光。另一種運用為將之黏在機器零件上增加耐磨耗及防止打滑。

Diamond powders are fully sprayed on the surface of copper foil, featuring in longer tool life. The diamond foils can be cut to any shape and size easily, and stick on to your own tools. Aggressive cutting action and wide range of grit sizes produce fast cutting or polishing on hard steels of any hardness, tungsten carbides, stones, glass and hard ceramics, etc.



尺寸 Size	粒度及訂購代號 Grit & Order No.								
	#120	#150	#200	#300	#400	#600	#800	#1200	#1800
10 x 100mm	DPF-1120	DPF-1150	DPF-1200	DPF-1300	DPF-1400	DPF-1600	DPF-1800	DPF-11200	DPF-11800
50 x 100mm	DPF-5120	DPF-5150	DPF-5200	DPF-5300	DPF-5400	DPF-5600	DPF-5900	DPF-51200	DPF-51800
100 x 100mm	DPF-10120	DPF-10150	DPF-10200	DPF-10300	DPF-10400	DPF-10600	DPF-10800	DPF-101200	DPF-101800



# Grinding Oil Stone for Mold

## 模具油石



材質半軟硬，含氧化鋁成份，具有高切削性能適用一般未經熱處理之鋼材，尤其是鋼鐵。

Suitable for mild-hardness material including aluminum oxide composition. The oil stones feature high grinding capability, making them suitable for general steels without heat treatment, especially for steel molds.

編號	番數	規格	單價
L2210	220	4"x1/4"x1/16"	50
L2310	320	4"x1/4"x1/16"	55
L2410	400	4"x1/4"x1/16"	55
L2610	600	4"x1/4"x1/16"	63
L2910	900	4"x1/4"x1/16"	66

編號	番數	規格	單價
L2101	150	6"x1/4"x1/8"	72
L2201	220	6"x1/4"x1/8"	72
L2301	320	6"x1/4"x1/8"	78
L2401	400	6"x1/4"x1/8"	78
L2601	600	6"x1/4"x1/8"	87
L2901	900	6"x1/4"x1/8"	91

編號	番數	規格	單價
L2102	150	6"x1/4"x1/4"	74
L2202	220	6"x1/4"x1/4"	74
L2302	320	6"x1/4"x1/4"	80
L2402	400	6"x1/4"x1/4"	80
L2602	600	6"x1/4"x1/4"	90
L2902	900	6"x1/4"x1/4"	105

編號	番數	規格	單價
L2103	150	6"x1/2"x1/8"	82
L2203	220	6"x1/2"x1/8"	82
L2303	320	6"x1/2"x1/8"	91
L2403	400	6"x1/2"x1/8"	91
L2603	600	6"x1/2"x1/8"	102
L2903	900	6"x1/2"x1/8"	119

編號	番數	規格	單價
L2108	150	6"x3/8"x3/8"	109
L2208	220	6"x3/8"x3/8"	109
L2308	320	6"x3/8"x3/8"	116
L2408	400	6"x3/8"x3/8"	116
L2608	600	6"x3/8"x3/8"	135
L2908	900	6"x3/8"x3/8"	166

編號	番數	規格	單價
L2109	150	6"x3/4"x1/4"	118
L2209	220	6"x3/4"x1/4"	118
L2309	320	6"x3/4"x1/4"	141
L2409	400	6"x3/4"x1/4"	141
L2609	600	6"x3/4"x1/4"	175
L2909	900	6"x3/4"x1/4"	218

編號	番數	規格	單價
L2112	120	6"x1"x1/4"	154
L2212	220	6"x1"x1/4"	154
L2312	320	6"x1"x1/4"	161
L2412	400	6"x1"x1/4"	161
L2612	600	6"x1"x1/4"	205

編號	番數	規格	單價
L2100	150	6"x1/2"x1/16"	78
L2200	220	6"x1/2"x1/16"	78
L2300	320	6"x1/2"x1/16"	87
L2400	400	6"x1/2"x1/16"	87
L2600	600	6"x1/2"x1/16"	100
L2900	900	6"x1/2"x1/16"	112

編號	番數	規格	單價
L2104	150	6"x1/2"x1/4"	95
L2204	220	6"x1/2"x1/4"	95
L2304	320	6"x1/2"x1/4"	116
L2404	400	6"x1/2"x1/4"	116
L2604	600	6"x1/2"x1/4"	122
L2904	900	6"x1/2"x1/4"	143

編號	番數	規格	單價
L2105	150	6"x1/2"x1/2"	127
L2205	220	6"x1/2"x1/2"	127
L2305	320	6"x1/2"x1/2"	147
L2405	400	6"x1/2"x1/2"	147
L2605	600	6"x1/2"x1/2"	190
L2905	900	6"x1/2"x1/2"	207

編號	番數	規格	單價
L2111	120	6"x1"x1/8"	139
L2211	220	6"x1"x1/8"	139
L2311	320	6"x1"x1/8"	145
L2411	400	6"x1"x1/8"	145
L2611	600	6"x1"x1/8"	198

編號	番數	規格	單價
L2107	150	6"x1"x1/2"	201
L2207	220	6"x1"x1/2"	201
L2307	320	6"x1"x1/2"	253
L2407	400	6"x1"x1/2"	253
L2607	800	6"x1"x1/2"	346
L2907	900	6"x1"x1/2"	405

編號	番數	規格	單價
L2106	150	6"x1"x1"	353
L2206	220	6"x1"x1"	353
L2306	320	6"x1"x1"	394
L2406	400	6"x1"x1"	394
L2606	600	6"x1"x1"	550



## Grinding Oil Stone for EDM

### 放電油石 " EDM "



此材質堅硬，切削能力高，專攻放電加工後表皮處理，且不損及鋼模表皮。  
The oil stones are extra-hard materials, providing high grinding capability. They are excellent for surface treatment after EDM machining without damage to steel mold surfaces.

編號	番數	規格	單價
L6121	120	6"x1/4"x1/8"	88
L6181	180	6"x1/4"x1/8"	88
L6301	320	6"x1/4"x1/8"	96
L6401	400	6"x1/4"x1/8"	105
L6601	600	6"x1/4"x1/8"	121

編號	番數	規格	單價
L6120	120	8"x1/2"x1/16"	95
L6180	180	8"x1/2"x1/16"	95
L6300	320	8"x1/2"x1/16"	104
L6400	400	8"x1/2"x1/16"	118
L6600	600	8"x1/2"x1/16"	135

編號	番數	規格	單價
L6122	120	6"x1/4"x1/4"	101
L6182	180	6"x1/4"x1/4"	101
L6302	320	6"x1/4"x1/4"	108
L6402	400	6"x1/4"x1/4"	113
L6602	600	6"x1/4"x1/4"	124

編號	番數	規格	單價
L6123	120	6"x1/2"x1/8"	105
L6183	180	6"x1/2"x1/8"	105
L6303	320	6"x1/2"x1/8"	113
L6403	400	6"x1/2"x1/8"	118
L6603	800	6"x1/2"x1/8"	142

編號	番數	規格	單價
L6128	120	6"x3/8"x3/8"	124
L6188	180	6"x3/8"x3/8"	124
L6308	320	6"x3/8"x3/8"	133

編號	番數	規格	單價
L6124	120	6"x1/2"x1/4"	111
L6184	180	6"x1/2"x1/4"	111
L6304	320	6"x1/2"x1/4"	124
L6404	400	6"x1/2"x1/4"	135
L6604	600	6"x1/2"x1/4"	164

編號	番數	規格	單價
L61T2	120	6"x1/4"	112
L62T2	220	6"x1/4"	112
L63T2	320	6"x1/4"	119

編號	番數	規格	單價
LE122	120	6"x1/4"xRound	154
LE182	180	6"x1/4"xRound	154
LE302	320	6"x1/4"xRound	196

編號	番數	規格	單價
L6126	120	6"x1"x1"	338
L6186	180	6"x1"x1"	338
L6306	320	6"x1"x1"	423

編號	番數	規格	單價
L61T8	120	6"x3/8"	143
L62T8	220	6"x3/8"	143
L63T8	320	6"x3/8"	153



## Diamond Compounds

### 鑽石膏



鑽石膏  
Diamond Compounds

- ★ 種類：油溶性。
- ★ 包裝：注射筒式包裝，每支5公克裝。
- ★ 鑽石粉容量：高濃度。
- ▲ Carrier classifications: Oil soluble.
- ▲ Containers: Plastic syringes, 5 grams per syringe.
- ▲ Diamond Concentrations: heavy concentrations.

### 規格 / Specifications

5 grams net

Heavy Order No.	LV 002	LV 004	LV 006	LV 008	LV 010	LV 012	LV 015	LV 018	LV 020	LV 030	LV 050	LV 080	LV 140	LV 280	LV 600
Mesh Size	#200	#400	#600	#900	#1,000	#1,200	#1,500	#1,800	#2,000	#3,000	#5,000	#8,000	#14,000	#28,000	#60,000
Micron Range (μm)	90 μ (80-100)	50 μ (40-60)	35 μ (30-40)	25 μ (20-30)	17.5 μ (15-20)	15 μ (10-20)	13 μ (10-18)	9 μ (8-12)	8 μ (6-10)	6 μ (4-8)	4.5 μ (3-6)	3 μ (2-4)	1 μ (0-2)	0.5 μ (0-1)	0.25 μ (0-0.5)
Color	黑 BLACK	紫 PURPLE	紅 RED	咖啡 BROWN	深綠 DARK GREEN	藍 BLUE	粉紅 PINK	綠 GREEN	淺藍 LIGHT BLUE	橙 ORANGE	淺棕色 LIGHT BROWN	黃 YELLOW	白 WHITE	灰 GREY	銀 SILVER
Color															

說明：1.標準規格品為油溶性，若需水溶性鑽石膏，請指明訂購。

2.請配合本公司的稀釋油使用，可使拋光效果更佳。

Note: 1.Oil soluble is standard carries, other carries depend on your requirement.

2.We also supply thinners, help you to do better polishing performance.



## 德國羊毛輪 *Felt Bobs*

### Ø3柄 (Ø3 Diameter)



**說明:**

羊毛密度高，加鑽石膏或膏土拋光劑研磨，材質本身不變形並可保持鋼材亮度無線痕。

**Features:**

Together with the use of diamond paste or lapping compound, this high intensive felt enables to keep the shape of materials and shining of steel without line marks.

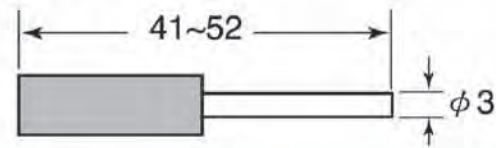

圖型 Form							
編號 Order No.	AB-0408A	AB-0509A	AB-0610A	AB-0810A	AB-1014A	AB-1220A	AB-2020A

圖型 Form							
編號 Order No.	AB-0408C	AB-0509C	AB-0610C	AB-0810C	AB-1013C	AB-1214C	AB-1220C

圖型 Form							
編號 Order No.	AB-0410J	AB-0512J	AB-0616J	AB-0817J	AB-1014J	AB-1020J	AB-1220J

圖型 Form							
編號 Order No.	AB-1225J	AB-08B	AB-10B	AB-12B	AB-18B	AB-1014R	AB-1225R

圖型 Form					
編號 Order No.	AB-1218T	AB-1218H	AB-2503E	AB-2505E	AK-300



## 德國羊毛輪 *Felt Bobs*

### Ø2.34柄 (Ø2.34 Diameter)



**說明:**

羊毛密度高，加鑽石膏或膏土拋光劑研磨，材質本身不變形並可保持鋼材亮度無線痕。

**Features:**

Together with the use of diamond paste or lapping compound, this high intensive felt enables to keep the shape of materials and shining of steel without line marks.

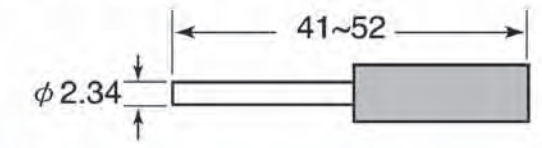

圖型 Form							
編號 Order No.	AH-515A	AH-615A	AH-815A	AH-1015A	AH-1020A	AH-1220A	AH-1520A

圖型 Form							
編號 Order No.	AH-2025A	AH-80B	AH-100B	AH-120B	AH-150B	AH-512J	AH-616J

圖型 Form							
編號 Order No.	AH-817J	AH-1020J	AH-1220J	AH-1525J	AH-610K	AH-810K	AH-1015K

圖型 Form							
編號 Order No.	AH-1320K	AH-1525K	AH-1016Q	AH-1320Q	AH-1018T	AH-1220T	AH-810R

圖型 Form							
編號 Order No.	AH-1013R	AH-1320R	AH-1520R	AH-2025R	AH-610H	AH-1318H	AK-234



## 德國羊毛輪 *Felt Bobs*

### Ø6柄 (Ø6 Diameter)



**說明:**

使用高密度的羊毛壓縮成形，加鑽石膏或膏土拋光研磨，材質本身不變形並可保持亮度無研磨痕。

**Features:**

Compressed by the high intensive wool. This, Together with the use of diamond paste or lapping compound, enables to keep the shape of materials and shining of steel without line marks.

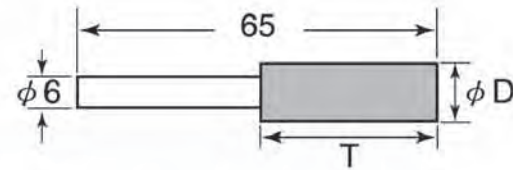

圖型 Form						
編號 Order No.	AL-120A	AL-150A	AL-200A	AL-250A	AL-320E	AL-400E

圖型 Form						
編號 Order No.	AL-150C	AL-200C	AL-250C	AL-150K	AL-200K	AL-250K

形狀 Shape	編號 Order No.	外徑 x 厚度 x 孔徑 (DiaØ x Thick x HoleØ) m/m
	FB 0751295	75 x 12 x 9.5
	FB 1501012	150 x 10 x 12
	FB 2051016	205 x 10 x 16
	FB 2551025	255 x 10 x 25
	FB 2551525	255 x 15 x 25

用途：一般金屬表面鏡面研磨處理

Usage: For the general metal surface / mirror grinding treatment



## 棕刷系列 *Brush Series*

### YE Series 系列 馬毛棕刷 *Horse Hair Brushes*

形狀 尺寸 Form								
編號 Order No.	YEA 5	YEA 6	YEA 8	YET 20	YET 25	YET 30	YEF 10	YEF 15

### YB Series 系列 銅線刷 *Copper Wire Brushes*

形狀 尺寸 Form								
編號 Order No.	YBA 5	YBA 6	YBA 8	YBT 20	YBT 25	YBT 30	YBF 10	YBF 15

### YX Series 系列 羊毛棕刷 *Wool Brushes*

形狀 尺寸 Form								
編號 Order No.	YXA 5	YXA 6	YXA 8	YXT 20	YXT 25	YXT 30	YXF 10	YXF 15

### YO Series 系列 豬毛棕刷 *Boar Hair Brushes*

形狀 尺寸 Form								
編號 Order No.	YOA 5	YOA 6	YOA 8	YOT 20	YOT 25	YOT 30	YOF 10	YOF 15



## 棕刷系列 *Brush Series*

### YS Series 系列 不銹鋼線刷 *Stainless Steel Wire Brushes*

形狀 尺寸 Form								
編號 Order No.	YSA 5	YSA 6	YSA 8	YST 20	YST 25	YST 30	YSF 10	YSF 15

### YC Series 系列 矽鋼尼龍刷 *Silicon Steel Nylon Brushes*

形狀 尺寸 Form								
編號 Order No.	YCA 5	YCA 6	YCA 8	YCT 20	YCT 25	YCT 30	YCF 10	YCF 15

### LA Series 系列 砂布環 *Contact Wheels*

形狀 尺寸 Form					
編號 Order No.	LA 34	LA 44	LA 55	LA 66	LA 110

可選粒度 #40 #60 #80 #120

### LP Series 系列 橡膠柄 *Rubber Handles*

形狀 尺寸 Form							
編號 Order No.	LP 343	LP 346	LP 443	LP 446	LP 556	LP 666	LP 116



## 粉紅色帶柄砂輪 *Pink Mounted Points*



圖型 Form							
編號 Order No.	256A	308A	410A	510A	612A	816A	1016A

圖型 Form							
編號 Order No.	30B	40B	50B	60B	80B	100B	120B

圖型 Form							
編號 Order No.	308T	310T	412T	710T	813R	1224R*	609S

圖型 Form							
編號 Order No.	412J	616J	816J	1016J	612P	815P	1018P*

圖型 Form							
編號 Order No.	306K	412K	515K	816K	132E-133E	162E*	163E*

可選用支柄徑/Shank Diameter Available:  
 Ø2.34、Ø3.0 & Ø3.175    \*\* Just for Ø3.0 and Ø3.175 shank



## 彈性帶柄砂輪 *Elastic Mounted Points*



### CLW 彈性帶柄砂輪 (牛皮輪) Elastic Mounted Points (Leather Wheel)

編號 Order No.	外徑 x 厚度 x 柄徑 (Dia Φ x Thick x Hole Φ) mm
CLW03123	3 x 12 x 3
CLW04133	4 x 13 x 3
CLW05163	5 x 16 x 3
CLW06173	6 x 17 x 3
CLW08203	8 x 20 x 3
CLW10203	10 x 20 x 3
CLW13203	13 x 20 x 3
CLW22043	22 x 4 x 3
CLW13206	13 x 20 x 6
CLW15256	15 x 25 x 6
CLW20256	20 x 25 x 6
CLW25256	25 x 25 x 6
CLW38106	38 x 10 x 6

※CLW: 次硬100# · 用途: 一般金屬拋光。

※CLW: Second Hardness 100#

Usage: General Metal Grinding.

### SW 彈性帶柄砂輪 (海綿輪) Elastic Mounted Points (Sponge Wheel)

編號 Order No.	外徑 x 厚度 x 柄徑 (Dia Φ x Thick x Hole Φ) mm
SW03123	3 x 12 x 3
SW04133	4 x 13 x 3
SW05163	5 x 16 x 3
SW06173	6 x 17 x 3
SW08203	8 x 20 x 3
SW10203	10 x 20 x 3
SW13203	13 x 20 x 3
SW22043	22 x 4 x 3
SW13256	13 x 25 x 6
SW15256	15 x 25 x 6
SW20256	20 x 25 x 6
SW25256	25 x 25 x 6
SW38106	38 x 10 x 6

※SW: 超級海綿120# · 用途: 鋁合金、鐵拋光

※SW: Super Sponge 120#

Usage: For Aluminum Alloy and Iron Grinding.



## 錫鋼滾磨刀 *Solid Carbide*

3.0mm Shank Diameter- 38mm Overall Length



交叉紋、單斜紋  
Cross Lines,  
Single Sliding Lines

型號Model	SA-41M	SA-42M	SA-43M	SB-43M	SC-41M	SC-42M	SD-41M	SD-42M
直徑Diameter	1.5	2.5	3.0	3.0	2.5	3.0	2.5	3.0
刃長Blade Length	6.0	11.0	14.0	14.0	11.0	14.0	2.3	2.8
全長Total Length	38	38	38	38	38	38	38	38



交叉紋、單斜紋  
Cross Lines,  
Single Sliding Lines

型號Model	SE-41M	SF-41M	SF-42M	SG-41M	SG-43M	SG-44M	SH-41M
直徑Diameter	3.0	3.0	3.0	3.0	3.0	3.0	3.0
刃長Blade Length	5.5	6.0	12.7	6.0	9.5	12.7	6.3
全長Total Length	38	38	38	38	38	38	38



交叉紋、單斜紋  
Cross Lines,  
Single Sliding Lines

型號Model	SL-41M	SL-42M	SM-41M	SM-42M	SM-43M	SN-41M	SN-42M
直徑Diameter	3.0	3.0	3.0	3.0	3.0	2.5	3.0
刃長Blade Length	5.5	12.7	8.9	11.0	16.0	3.0	4.0
全長Total Length	38	38	38	38	38	38	38



## 錫鋼滾磨刀 Solid Carbide

### 3.0mm Shank Diameter- 38~53mm Overall Length

3.0mm Shank  
(交叉紋)  
SB上刀刃  
(Cross Lines)  
SB Upper Blade



型號Model	SA-52M SB-52M	SA-53M SB-53M	SC-52M	SC-53M	SD-52M	SD-53M	SE-53M
直徑Diameter	4.0	5.0	4.0	5.0	4.0	5.0	5.0
刃長Blade Length	12.7	12.7	12.7	12.7	3.8	4.7	7.1
全長Total Length	38	38	38	38	38	38	38



型號Model	SF-53M	SG-53M	SH-53M	SL-53M	SM-53M	SN-53M
直徑Diameter	5.0	5.0	5.0	5.0	5.0	5.0
刃長Blade Length	12.7	12.7	9.5	12.7	12.7	6.3
全長Total Length	38	38	38	38	38	38

※以上規格其柄徑整支產品係全鎢鋼製成 \* Above specifications and whole shanks are made of tungsten steel.

3.0mm Shank  
交叉紋、單斜紋  
Cross Lines,  
Single Sliding Lines



型號Model	SA-51M	SA-51M/EC	SB-51M	SC-51M	SD-51M
直徑Diameter	6.3	6.3	6.3	6.3	6.3
刃長Blade Length	12.7	12.7	4.7	12.7	5
全長Total Length	50	50	43	50	44



型號Model	SE-51M	SF-51M	SG-51M	SM-51M	SN-51M
直徑Diameter	6.3	6.3	6.3	6.3	6.3
刃長Blade Length	9.5	12.7	12.7	12.7	6
全長Total Length	47	50	50	53	44



## 錫鋼滾磨刀 Solid Carbide

### 3.0mm Shank Diameter-38mm Overall Length

鋁質、硬木材專用 Aluminum, Hard Wood Use



型號Model	AL-60A	AL-60C	AL-60D	AL-60E	AL-60F	AL-60G	AL-60L	AL-60N	BT-60M	BT-60W
直徑Diameter	6	6	6	6	6	6	6	6	6	6
刃長Blade Length	12.7	12.7	6	10	12.7	12.7	12.7	10	3.2	3.2
全長Total Length	38	38	38	38	38	38	38	38	38	38



型號Model	AL-53A	AL-53C	AL-53D	AL-53E	AL-53F	AL-53G	AL-53L	AL-80B	BB-80	BT-80M	BT-80W
直徑Diameter	5.0	5.0	5.0	5.0	5.0	5.0	5.0	8.0	8.0	8.0	8.0
刃長Blade Length	12.7	12.7	4.5	10	12.7	12.7	12.7	8.0	8.0	3.7	3.7
全長Total Length	38	38	38	38	38	38	38	38	38	38	38



型號Model	GT1.0	GT1.5	GT2.0	GT2.5	GT3.0	GT1.0R	GT1.5R	GT2.0R	GT2.5R	GT3.0R
直徑Diameter	12	12	12	12	12	12	12	12	12	12
刃長Blade Length	1.0	1.5	2.0	2.5	3.0	1	1.5	2.0	2.5	3.0





## 錫鋼滾磨刀 Solid Carbide

6.0mm Shank Diameter- 55~65mm Overall Length

(交叉紋、單斜紋) (Cross Lines, Single Sliding Lines)

形狀 Shape	型號 Series No.	直徑 x 刃長 Dia. X Blade Length
	SA-13M	4.0mm x 16.0mm
	SA-14M	5.0 x 16.0
	SA-1M	6.0 x 16.0
	SA-2M	8.0 x 19.0
	SA-3M	9.5 x 19.0
	SA-5M	12.7 x 25.0
	SA-6M	16.0 x 25.0
	SA-7M	19.0 x 25.0
	SA-9M	25.0 x 25.0

柄徑 6mm (Shank Dia. 6mm)

形狀 Shape	型號 Series No.	直徑 x 刃長 Dia. X Blade Length
	SB-13M	4.0mm x 16.0mm
	SB-14M	5.0 x 16.0
	SB-1M	6.0 x 16.0
	SB-2M	8.0 x 19.0
	SB-3M	9.5 x 19.0
	SB-5M	12.7 x 25.0
	SB-6M	16.0 x 25.0
	SB-7M	19.0 x 25.0
	SB-9M	25.0 x 25.0

形狀 Shape	型號 Series No.	直徑 x 刃長 Dia. X Blade Length
	SC-13M	4.0mm x 16.0mm
	SC-14M	5.0 x 16.0
	SC-1M	6.0 x 16.0
	SC-2M	8.0 x 19.0
	SC-3M	9.5 x 19.0
	SC-5M	12.7 x 25.0
	SC-6M	16.0 x 25.0
	SC-7M	19.0 x 25.0
	SC-9M	25.0 x 25.0

形狀 Shape	型號 Series No.	直徑 x 刃長 Dia. X Blade Length
	SD-14M	5.0mm x 4.0mm
	SD-1M	6.0 x 5.0
	SD-2M	8.0 x 6.4
	SD-3M	9.5 x 8.0
	SD-5M	12.7 x 11.0
	SD-6M	16.0 x 14.0
	SD-7M	19.0 x 16.0
	SD-9M	25.0 x 23.0



## 錫鋼滾磨刀 Solid Carbide

6.0mm Shank Diameter- 55~65mm Overall Length

(交叉紋、單斜紋) (Cross Lines, Single Sliding Lines)

形狀 Shape	型號 Series No.	直徑 x 刃長 Dia. X Blade Length
	SE-1M	6.0mm x 9.5mm
	SE-3M	9.5 x 16.0
	SE-5M	12.7 x 22.0
	SE-6M	16.0 x 25.0
	SE-7M	19 x 25.0

柄徑 6mm (Shank Dia. 6mm)

形狀 Shape	型號 Series No.	直徑 x 刃長 Dia. X Blade Length
	SF-1M	6.0mm x 16.0mm
	SF-3M	9.5 x 19.0
	SF-5M	12.7 x 25.0
	SF-6M	16.0 x 25.0
	SF-7M	19.0 x 25.0
	SF-14M	19.0 x 32.0
	SF-15M	19.0 x 38.0

形狀 Shape	型號 Series No.	直徑 x 刃長 Dia. X Blade Length
	SG-1M	6.0mm x 16.0mm
	SG-2M	8.0 x 19.0
	SG-3M	9.5 x 19.0
	SG-5M	12.7 x 25.0
	SG-6M	16.0 x 25.0
	SG-7M	19.0 x 25.0
	SG-15M	19.0 x 38.0

形狀 Shape	型號 Series No.	直徑 x 刃長 Dia. X Blade Length
	SH-1M	6.0mm x 16.0mm
	SH-2M	8.0 x 19.0
	SH-5M	12.7 x 32.0
	SH-6M	16.0 x 36.0
	SH-7M	19.0 x 41.0





## 錫鋼滾磨刀 Solid Carbide

6.0mm Shank Diameter- 55~65mm Overall Length

(交叉紋、單斜紋) (Cross Lines, Single Sliding Lines)

形狀 Shape	型號 Series No.	直徑 x 刃長 Dia. X Blade Length
	<b>SJ-1M</b>	6.0mm x 4.0 x 60°
	<b>SJ-3M</b>	9.5mm x 8.0 x 60°
	<b>SJ-5M</b>	12.7mm x 11.0 x 60°
	<b>SJ-6M</b>	16mm x 13.5 x 60°
	<b>SK-1M</b>	6.0mm x 3.0 x 90°
	<b>SK-3M</b>	9.5mm x 4.7 x 90°
	<b>SK-5M</b>	12.7mm x 6.3 x 90°
	<b>SK-6M</b>	16.0mm x 8.0 x 90°

形狀 Shape	型號 Series No.	直徑 x 刃長 Dia. X Blade Length
	<b>SM-1M</b>	6.0mm x 12.7mm
	<b>SM-2M</b>	6.0 x 19.0
	<b>SM-3M</b>	6.0 x 25.0
	<b>SM-4M</b>	9.5 x 16.0
	<b>SM-5M</b>	12.7 x 22.0
	<b>SM-6M</b>	16.0 x 25.0

柄徑 6mm (Shank Dia. 6mm)

形狀 Shape	型號 Series No.	直徑 x 刃長 Dia. X Blade Length
	<b>SL-1M</b>	6.0mm x 16.0mm
	<b>SL-2M</b>	8.0 x 22.0
	<b>SL-3M</b>	9.5 x 27.0
	<b>SL-4M</b>	12.7 x 28.0
	<b>SL-5M</b>	16.0 x 30.0
	<b>SL-7M</b>	19.0 x 38.0

形狀 Shape	型號 Series No.	直徑 x 刃長 Dia. X Blade Length
	<b>SN-1M</b>	6.0mm x 8.0mm
	<b>SN-2M</b>	9.5 x 9.5
	<b>SN-4M</b>	12.7 x 12.7
	<b>SN-6M</b>	16.0 x 19.0
	<b>SN-7M</b>	19.0 x 16.0









## 錫鋼滾磨刀 Solid Carbide

6.0mm Shank Diameter-55~65mm Overall Length

鋁質、硬木材專用 Aluminum, Hard Wood Use

柄徑 6mm (Shank Dia. 6mm)

形狀 Shape	編號 Series No.	直徑 x 邊長 Side Dia. X Side Length
	<b>SA-1MNF</b>	6.0 x 19
	<b>SA-2MNF</b>	8.0 x 19
	<b>SA-3MNF</b>	9.5 x 19
	<b>SA-5MNF</b>	12.7 x 25
	<b>SA-6MNF</b>	16.0 x 25
	<b>SA-7MNF</b>	19.0 x 25
	<b>SC-1MNF</b>	6.0 x 19
	<b>SC-3MNF</b>	9.5 x 19
	<b>SC-5MNF</b>	12.7 x 25
	<b>SC-6MNF</b>	16.0 x 25
	<b>SC-7MNF</b>	19.0 x 25
	<b>SD-1MNF</b>	6.0 x 5
	<b>SD-3MNF</b>	9.5 x 8.0
	<b>SD-5MNF</b>	12.7 x 11
	<b>SD-6MNF</b>	16.0 x 14
	<b>SE-3MNF</b>	9.5 x 16
	<b>SE-5MNF</b>	12.7 x 22
	<b>SE-6MNF</b>	16.0 x 25
	<b>SF-1MNF</b>	6.0 x 19
	<b>SF-3MNF</b>	9.5 x 19
	<b>SF-5MNF</b>	12.7 x 25
	<b>SL-3MNF</b>	9.5 x 27
	<b>SL-4MNF</b>	12.7 x 28
	<b>SL-5MNF</b>	16.0 x 30









## 鎢鋼滾磨刀 *Solid Carbide*

6.0mm Shank Diameter-55~65mm Overall Length

鋁質、硬木材專用 *Aluminum, Hard Wood Use*

柄徑 6mm (Shank Dia. 6mm)

形狀 Shape	編號 Series No.	徑徑 x 邊長 Side Dia. X Side Length
	SA-1MNF	6.0 x 19
	SA-2MNF	8.0 x 19
	SA-3MNF	9.5 x 19
	SA-5MNF	12.7 x 25
	SA-6MNF	16.0 x 25
	SA-7MNF	19.0 x 25
	SC-1MNF	6.0 x 19
	SC-3MNF	9.5 x 19
	SC-5MNF	12.7 x 25
	SC-6MNF	16.0 x 25
	SC-7MNF	19.0 x 25
	SD-1MNF	6.0 x 5
	SD-3MNF	9.5 x 8.0
	SD-5MNF	12.7 x 11
	SD-6MNF	16.0 x 14
	SE-3MNF	9.5 x 16
	SE-5MNF	12.7 x 22
	SE-6MNF	16.0 x 25
	SF-1MNF	6.0 x 19
	SF-3MNF	9.5 x 19
	SF-5MNF	12.7 x 25
	SF-6MNF	16.0 x 25
	SL-3MNF	9.5 x 27
	SL-4MNF	12.7 x 28
	SL-5MNF	16.0 x 30