

品牌專用槽刀
GROOVING HOLDER

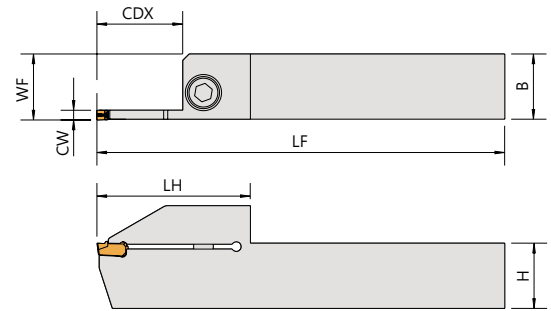

EVSC
EVSM
WIDIA /
KENNAMETAL

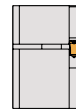
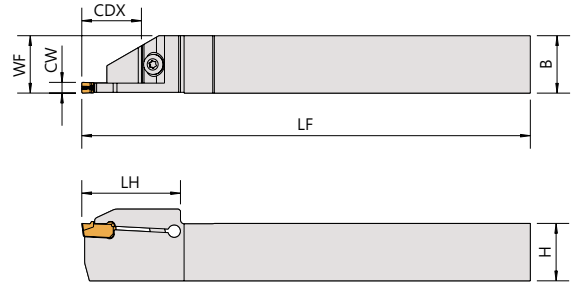
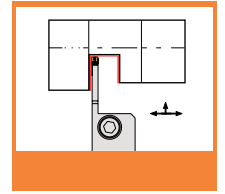

▼Recommended Inserts 建議刀片品牌: KENNAMETAL / WIDIA

Order No.	Insert	Dimensions(mm)							Parts	Wrench
		柄高	柄寬	長度	工作寬度	頭長	切寬	最大切深		
Right / Left		H	B	LF	WF	LH	CW	CDX		
EVSCR/L-1212K0210	EC020 WU25PT	12	12	125	12	21.5	2	10	CS50120	TL-20N
EVSCR/L-1212K0216		12	12	125	12	27.5	2	16		
EVSCR/L-1616K0216		16	16	125	16	27.5	2	16		
EVSCR/L-1616K0316	EC030 WU25PT	16	16	125	16	27.5	3	16	CSH0620	LW050
EVSMR-2020K0316	EC030 WU25PT	20	20	125	20.25	37	3	16		
EVSMR-2020K0326		20	20	125	20.25	47	3	26		
EVSMR-2525M0316		25	25	150	25.25	37	3	16		
EVSMR-2525M0326		25	25	150	25.25	47	3	26		
EVSMR-2525M0326C		25	25	150	25.25	47	3	26		

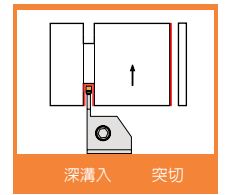
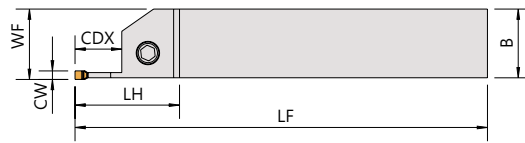

▼ Recommended Inserts 建議刀片品牌 : KENNAMETAL

Order No.	Insert	Dimensions(mm)							Parts	Wrench
		柄高	柄寬	長度	工作寬度	頭長	切寬	最大切深		
Right / Left		H	B	LF	WF	LH	CW	CDX		
GHR-1010H0210	A2022	10	10	100	10.3	20	2.25~3.05	10	CSH0412	LW030
GHR-1212H0210		12	12	100	12.3	20	2.25~3.05	10	CSH0412	LW030
GHR-1616H0216		16	16	100	16.3	30	2.25~3.05	16	CSH0514	LW040
GHR-2020K0216		20	20	125	20.3	38	2.25~3.05	16	CSH0616	LW050
GHR-1212H0310	A2030 A3G03	12	12	100	12.3	20	3.05~4.05	10	CSH0412	LW040
GHR-1616H0316		16	16	100	16.3	31	3.05~4.05	16	CSH0514	LW040
GHR-2020K0316		20	20	125	20.3	38	3.05~4.05	16	CSH0616	LW050
GHR-2020K0326		20	20	125	20.3	43	3.05~4.05	26	CSH0616	LW050
GHR-2525M0316		25	25	150	25.3	38	3.05~4.05	16	CSH0616	LW050
GHR-2525M0326		25	25	150	25.3	43	3.05~4.05	26	CSH0616	LW050
GHR-3225P0332		32	25	170	25.3	49	3.05~4.05	32	CSH0616	LW050
GHR-2020K0416	A2040 A3G04	20	20	125	20.3	38	4.05~5.05	16	CSH0616	LW050
GHR-2020K0426		20	20	125	20.3	43	4.05~5.05	26	CSH0616	LW050
GHR-2525M0416		25	25	150	25.3	38	4.05~5.05	16	CSH0616	LW050
GHR-2525M0426		25	25	150	25.3	43	4.05~5.05	26	CSH0616	LW050
GHR-3225P0432		32	25	170	25.3	49	4.05~5.05	32	CSH0616	LW050

GHDR

KENNAMETAL

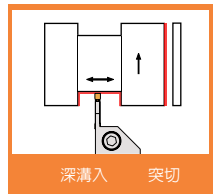
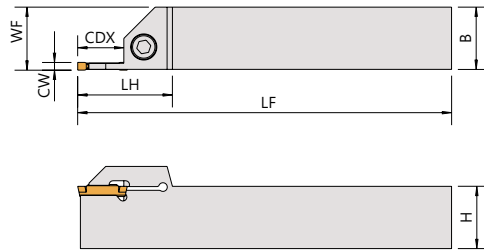

▼Recommended Inserts 建議刀片品牌: KENNAMETAL

Order No.	Insert	Dimensions(mm)							Parts	Wrench
		柄高	柄寬	長度	工作寬度	頭長	切寬	最大切深		
Right / Left		H	B	LF	WF	LH	CW	CDX		
GHDR-1616H0314	A4G03	16	16	100	16.3	32	3	14	CSH0514	LW040
GHDR-2020K0314		20	20	125	20.3	32	3	14	CSH0616	LW050
GHDR-2525M0317		25	25	150	25.3	35	3	17	CSH0616	LW050
GHDR-2020K0414	A4G04	20	20	125	20.3	30	4	14	CSH0616	LW050
GHDR-2525M0417		25	25	150	25.3	35	4	17	CSH0616	LW050
GHDR-3225P0417		32	25	170	32.3	37	4	17	CSH0616	LW050
GHDR-2020K0519	A4G05	20	20	125	20.3	32	5	19	CSH0616	LW050
GHDR-2525M0520		25	25	150	25.3	35	5	20	CSH0616	LW050
GHDR-3225P0522		32	25	170	32.3	44	5	22	CSH0616	LW050
GHDR-2525M0620	A4G06	25	25	150	25.4	44	6	20	CSH0616	LW050
GHDR-3225P0626		32	25	170	32.4	44	6	26	CSH0616	LW050
GHDR-2525M0820	A4G08	25	25	150	25.4	46	8	20	CSH0616	LW050
GHDR-3225P0826		32	25	170	32.4	46	8	26	CSH0616	LW050

A-GIDR

KENNAMETAL

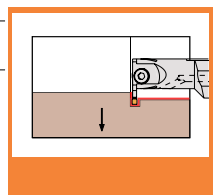
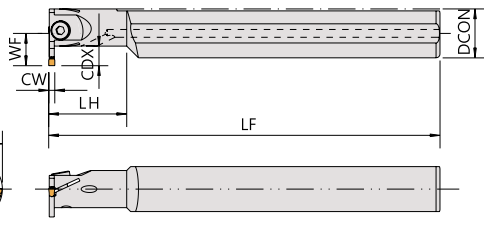
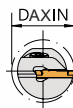

▼Recommended Inserts 建議刀片品牌: KENNAMETAL

Order No.	Insert	Dimensions(mm)							Parts	Wrench
		柄徑	工作寬度	長度	最小加工徑	頭長	切寬	最大切深		
Right / Left		DCON	WF	LF	DAXIN	LH	CW	CDX		
A20R-GIDR307	A4G03	20	12.5	200	23	40	3	7	CSH0410	LW030
A25R-GIDR310		25	17	200	32	50	3	10	CSH0512	LW040
A32S-GIDR312		32	22	250	40	64	3	12	CSH0516	LW040
A20R-GIDR407	A4G04	20	12.5	200	25	40	4	7	CSH0410	LW030
A25R-GIDR410		25	17	200	32	50	4	10	CSH0512	LW040
A32S-GIDR412		32	22	250	40	64	4	12	CSH0516	LW040
A40T-GIDR416		40	30	300	52	80	4	16	CSH0520	LW040
A32S-GIDR516	A4G05	32	26	250	44	64	5	16	CSH0516	LW040
A40T-GIDR516		40	30	300	52	80	5	16	CSH0520	LW040
A40T-GIDR616	A4G06	40	30	300	52	80	6	16	CSH0520	LW040

GNDFL
SUMITOMO

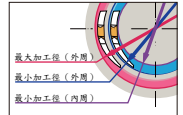
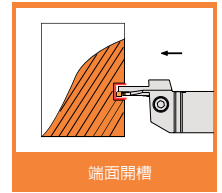
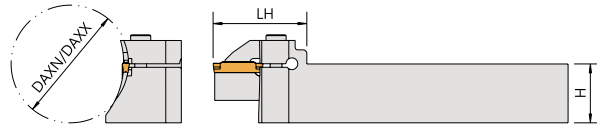

▼ Recommended Inserts 建議刀片品牌：SUMITOMO

Order No.	Insert	Dimensions(mm)								Parts	Wrench
		柄高 H	柄寬 B	長度 LF	工作寬度 WF	頭長 LH	切寬 CW	最大切深 CDX	加工直徑範圍 DAXN/DAXX		
GNDFL2525M-312-035	GCMN30	25	25	150	25	33.6	3	12	35~45	CSH0516	LW040
GNDFL2525M-312-040		25	25	150	25	33.6	3	12	40~55	CSH0516	LW040
GNDFL2525M-313-035		25	25	150	25	33.6	3	13	35~45	CSH0516	LW040
GNDFL2525M-313-040		25	25	150	25	33.6	3	13	40~55	CSH0516	LW040
GNDFL2525M-313-050		25	25	150	25	33.6	3	13	50~70	CSH0516	LW040
GNDFL2525M-313-065		25	25	150	25	33.6	3	13	65~100	CSH0516	LW040
GNDFL2525M-313-090		25	25	150	25	33.6	3	13	90~150	CSH0516	LW040
GNDFL2525M-313-125		25	25	150	25	33.6	3	13	125~200	CSH0516	LW040
GNDFL2525M-314-065		25	25	150	25	34.6	3	14	65~100	CSH0516	LW040
GNDFL2525M-314-090		25	25	150	25	34.6	3	14	90~150	CSH0516	LW040
GNDFL2525M-314-125		25	25	150	25	34.6	3	14	125~200	CSH0516	LW040
GNDFL2525M-314-180		25	25	150	25	34.6	3	14	180~300	CSH0516	LW040
GNDFL2525M-314-280		25	25	150	25	34.6	3	14	280~1000	CSH0516	LW040
GNDFL2525M-318-050		25	25	150	25	39.6	3	18	50~70	CSH0516	LW040
GNDFL2525M-318-065		25	25	150	25	39.6	3	18	65~100	CSH0516	LW040
GNDFL2525M-318-090		25	25	150	25	39.6	3	18	90~150	CSH0516	LW040
GNDFL2525M-318-140		25	25	150	25	39.6	3	18	140~200	CSH0516	LW040
GNDFL2525M-318-180		25	25	150	25	39.6	3	18	180~300	CSH0516	LW040
GNDFL2525M-418-040	GCMN40	25	25	150	25	39.6	4	18	40~55	CSH0516	LW040
GNDFL2525M-418-050		25	25	150	25	39.6	4	18	50~70	CSH0516	LW040
GNDFL2525M-418-065		25	25	150	25	39.6	4	18	65~100	CSH0516	LW040
GNDFL2525M-418-085		25	25	150	25	39.6	4	18	85~130	CSH0516	LW040
GNDFL2525M-418-125		25	25	150	25	39.6	4	18	125~200	CSH0516	LW040
GNDFL2525M-423-050		25	25	150	25	43.5	4	23	50~70	CSH0516	LW040
GNDFL2525M-423-065		25	25	150	25	43.5	4	23	65~90	CSH0516	LW040
GNDFL2525M-423-085		25	25	150	25	43.5	4	23	85~130	CSH0516	LW040
GNDFL2525M-423-125		25	25	150	25	43.5	4	23	125~200	CSH0516	LW040
GNDFL2525M-423-180		25	25	150	25	43.5	4	23	180~300	CSH0516	LW040
GNDFL2525M-423-280	25	25	150	25	43.5	4	23	280~1000	CSH0516	LW040	
GNDFL2525M-523-050	GCMN50	25	25	150	25	43.5	5	23	50~70	CSH0516	LW040
GNDFL2525M-523-065		25	25	150	25	43.5	5	23	65~90	CSH0516	LW040
GNDFL2525M-523-085		25	25	150	25	43.5	5	23	85~130	CSH0516	LW040
GNDFL2525M-523-125		25	25	150	25	43.5	5	23	125~200	CSH0516	LW040
GNDFL2525M-523-180		25	25	150	25	43.5	5	23	180~300	CSH0516	LW040

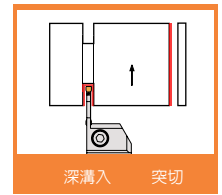
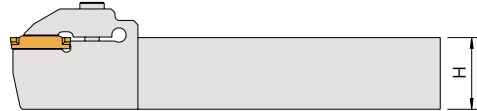
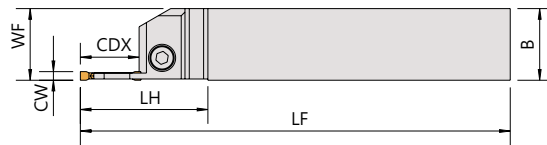
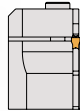

▼ Recommended Inserts 建議刀片品牌 : SUMITOMO

Order No.	Insert	Dimensions(mm)							Parts	Wrench
		柄高	柄寬	長度	工作寬度	頭長	切寬	最大切深		
Right / Left		H	B	LF	WF	LH	CW	CDX		
GNDMR/L1616K-217	GCMN20	16	16	125	16	45	2	17	CSH0516	LW040
GNDMR/L2020K-212		20	20	125	20	36	2	12	CSH0620	LW050
GNDMR/L2020K-220		20	20	125	20	36	2	20	CSH0620	LW050
GNDMR/L2525M-220		25	25	150	25	44	2	20	CSH0620	LW050
GNDMR/L1616K-317	GCMN30	16	16	125	16	45	3	17	CSH0520	LW050
GNDMR/L2020K-312		20	20	125	20	36	3	12	CSH0620	LW050
GNDMR/L2020K-320		20	20	125	20	44	3	20	CSH0620	LW050
GNDMR/L2525M-310		25	25	150	25	36	3	10	CSH0620	LW050
GNDMR/L2525M-312		25	25	150	25	36	3	12	CSH0620	LW050
GNDMR/L2525M-320		25	25	150	25	44	3	20	CSH0620	LW050
GNDMR/L2020K-410	GCMN40	20	20	125	20	36	4	10	CSH0620	LW050
GNDMR/L2020K-418		20	20	125	20	45	4	18	CSH0620	LW050
GNDMR/L2020K-425		20	20	125	20	50	4	25	CSH0620	LW050
GNDMR/L2525M-410		25	25	150	25	36	4	10	CSH0620	LW050
GNDMR/L2525M-418		25	25	150	25	45	4	18	CSH0620	LW050
GNDMR/L2525M-425		25	25	150	25	50	4	25	CSH0620	LW050
GNDMR/L2020K-518	GCMN50	20	20	125	20	45	5	18	CSH0620	LW050
GNDMR/L2020K-525		20	20	125	20	50	5	25	CSH0620	LW050
GNDMR/L2525M-518		25	25	150	25	45	5	18	CSH0620	LW050
GNDMR/L2525M-525		25	25	150	25	48	5	25	CSH0620	LW050



(自動車床専用)

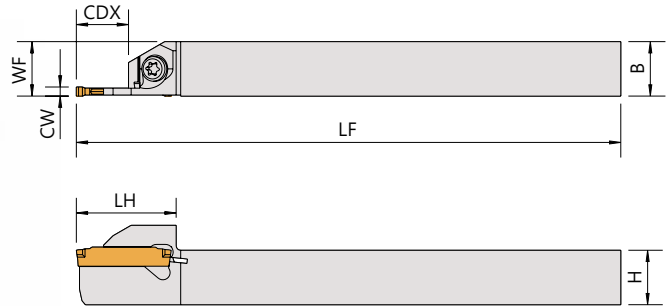
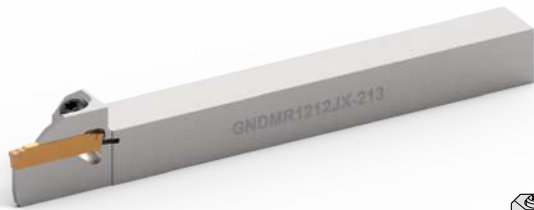
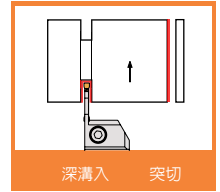

▼Recommended Inserts 建議刀片品牌：SUMITOMO

Order No.	Insert	Dimensions(mm)							Parts	Wrench
		柄高	柄寬	長度	工作寬度	頭長	切寬	最大切深		
Right / Left		H	B	LF	WF	LH	CW	CDX		
GNDMR/L1010K-206	GCMN20	10	10	125	10	22	2	6	CS40110	FT-15
GNDMR/L1010K-211		10	10	125	10	22	2	11	CS40110	FT-15
GNDMR/L1212K-211		12	12	125	12	22	2	11	CS40110	FT-15
GNDMR/L1212JX-213		12	12	120	12	22	2	13	CS40110	FT-15
GNDMR/L1616K-211		16	16	125	16	36	2	11	CSH0516	LW040
GNDMR/L1616JX-217		16	16	120	16	26	2	17	CS50130	TL-20N
GNDMR/L1212K-313	GCMN30	12	12	125	12	22	3	13	CS40110	FT-15
GNDMR/L1212JX-313		12	12	120	12	22	3	13	CS40110	FT-15
GNDMR/L1616JX-317		16	16	120	17	26	3	17	CS50130	TL-20N

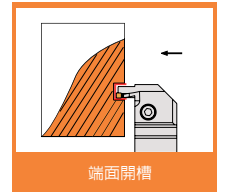
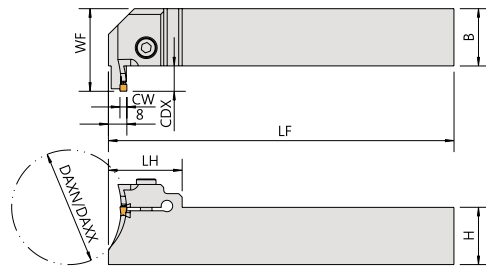

▼Recommended Inserts 建議刀片品牌: SUMITOMO

Order No.	Insert	Dimensions(mm)								Parts	Wrench
		柄高	柄寬	長度	工作寬度	頭長	切寬	最大切深	加工直徑範圍		
Right / Left		H	B	LF	WF	LH	CW	CDX	DAXN/DAXX		
GNDFSR2525M-209-025	GCMN200	25	25	150	36	32	2	9	25~35	CSH0620	LW050
GNDFSR2525M-209-035									35~45		
GNDFSR2525M-209-040									40~55		
GNDFSR2525M-209-050									50~70		
GNDFSR2525M-209-065									65~100		
GNDFSR2525M-209-090									90~150		
GNDFSR2525M-209-140									140~200		
GNDFSR2525M-209-180									180~300		
GNDFSR2525M-309-035	GCMN30	25	25	150	36	32	3	9	35~45	CSH0620	LW050
GNDFSR2525M-309-040									40~55		
GNDFSR2525M-309-050									50~70		
GNDFSR2525M-309-065									65~100		
GNDFSR2525M-309-090									90~150		
GNDFSR2525M-309-140									140~200		
GNDFSR2525M-309-180	180~300										
GNDFSR2525M-410-040	GCMN40	25	25	150	37	32	4	10	40~55	CSH0620	LW050
GNDFSR2525M-410-050									50~70		
GNDFSR2525M-410-065									65~90		
GNDFSR2525M-410-085									85~130		
GNDFSR2525M-410-125									125~200		
GNDFSR2525M-410-180									180~300		
GNDFSR2525M-410-280	280~1000										
GNDFSR2525M-516-050	GCMN50	25	25	150	43	32	5	16	50~70	CSH0620	LW050
GNDFSR2525M-516-065									65~90		
GNDFSR2525M-516-085									85~130		
GNDFSR2525M-516-125									125~200		
GNDFSR2525M-516-180									180~300		
GNDFSR2525M-516-280									280~1000		

**GNDIR
GNDIR-B**
SUMITOMO

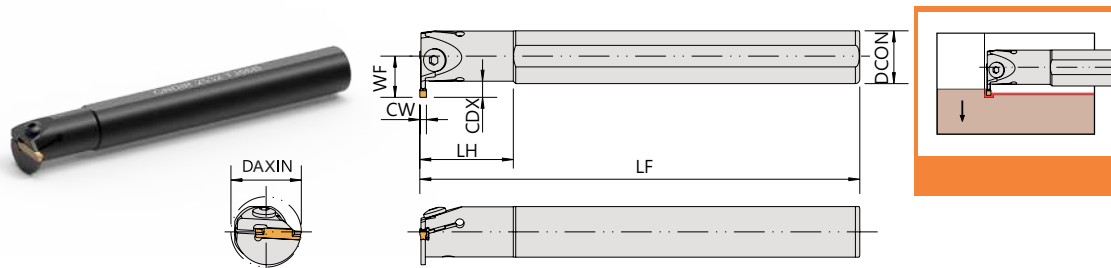

▼Recommended Inserts 建議刀片品牌：SUMITOMO

GNDIR with coolant, GNDIR-B without coolant

Order No.	Insert	Dimensions(mm)							Parts	Wrench		
		柄徑 DCON	工作寬度 WF	長度 LF	最小加工徑 DAXIN	頭長 LH	切寬 CW	最大切深 CDX				
GNDIR2024-T204	GCMN20	20	14	200	24	30	2	4	CSB0516	LW030		
GNDIR2532-T206		25	19	200	32	40	2	6				
GNDIR2026-T306	GCMN30	20	16	200	26	30	3	6	CSB0516	LW030		
GNDIR2532-T306		25	19	200	32	40	3	6				
GNDIR3240-T310		32	26	250	40	50	3	10			CSB0620	LW040
GNDIR4050-T311		40	31	300	50	60	3	11				
GNDIR2030-T410	GCMN40	20	20	200	30	30	4	10	CSB0516	LW030		
GNDIR2532-T406		25	19	200	32	40	4	6				
GNDIR3240-T410		32	24	250	40	50	4	10			CSB0620	LW040
GNDIR4050-T411		40	30	300	50	60	4	11				
GNDIR2024-T204B	GCMN20	20	14	150	24	20	2	4	CSB0516	LW030		
GNDIR2532-T206B		25	16	150	32	25	2	6				
GNDIR2026-T306B	GCMN30	20	16	150	26	20	3	6	CSB0516	LW030		
GNDIR2532-T306B		25	19	150	32	25	3	6				
GNDIR3240-T310B		32	26	200	40	32	3	10			CSB0620	LW040
GNDIR4050-T311B		40	30	250	50	40	3	11				
GNDIR5060-T311B		50	35	300	60	50	3	11	CSB0620	LW040		
GNDIR2532-T406B	GCMN40	25	19	150	32	25	4	6	CSB0516	LW030		
GNDIR3240-T410B		32	24	200	40	32	4	10				
GNDIR4050-T411B		40	30	250	50	40	4	11			CSB0620	LW040
GNDIR5060-T411B		50	35	300	60	50	4	11				
GNDIR3240-T510B	GCMN50	32	24	200	40	32	5	10	CSB0620	LW040		
GNDIR4050-T511B		40	30	250	50	40	5	11				
GNDIR5060-T511B		50	35	300	60	50	5	11				

GNDIFR-X
GNDIFR
SUMITOMO

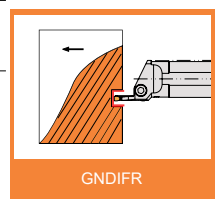
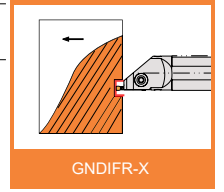
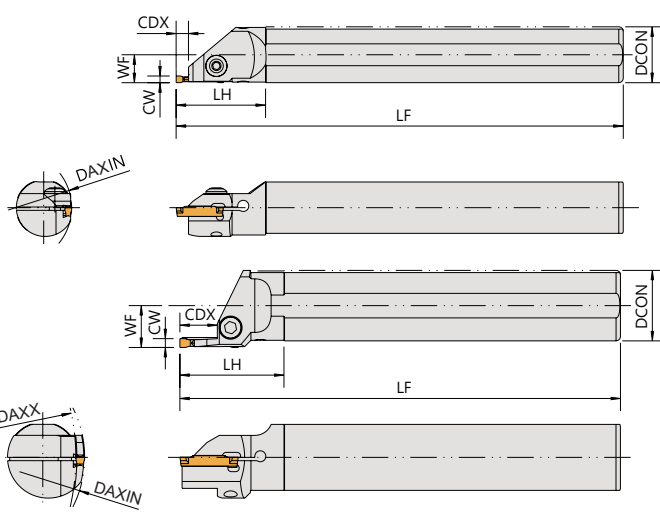
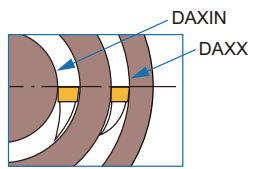

▼Recommended Inserts 建議刀片品牌：SUMITOMO

Order No.	Insert	Dimensions(mm)								Parts	Wrench
		柄徑	工作寬度	長度	最小加工徑	最大加工徑	頭長	切寬	最大切深		
Right / Left		DCON	WF	LF	DAXIN	DAXX	LH	CW	CDX		
GNDIFR25T205X	GCMN20	25	12.5	200	30	90	45	2	5	CSH0516	LW030
GNDIFR25T305X	GCMN30	25	12.5	200	35	90	40	3	5		
GNDIFR25T405X	GCMN40	25	12.5	200	40	90	40	4	5		
GNDIFR32T310-50-100	GCMN30	32	17	200	50	100	48	3	10	CSH0620	LW040
GNDIFR32T312-100-200		32	17	200	100	200	48	3	12		
GNDIFR32T312-200-800		32	17	200	200	800	48	3	12		
GNDIFR32T325-100-200		32	17	200	100	200	62	3	25		
GNDIFR32T411-50-100	GCMN40	32	17	200	50	100	48	4	11		
GNDIFR32T415-100-200		32	19	200	100	200	47	4	15		
GNDIFR32T415-200-800		32	19	200	200	800	47	4	15		
GNDIFR32T523-100-200	GCMN50	32	17	200	100	200	60	5	23		
GNDIFR32T523-200-800		32	17	200	200	800	60	4	23		

GNDER
GNDXER
SUMITOMO

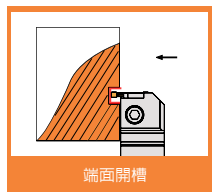
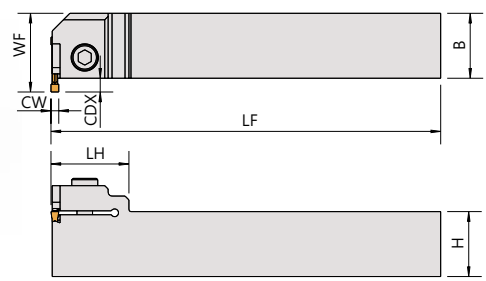
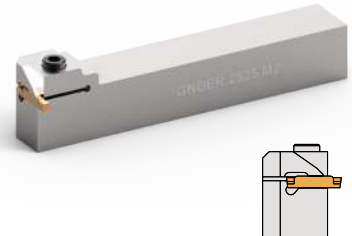

▼Recommended Inserts 建議刀片品牌：SUMITOMO

Order No.	Insert	Dimensions(mm)							Parts	Wrench
		柄高	柄寬	長度	工作寬度	頭長	切寬	最大切深		
Right / Left		H	B	LF	WF	LH	CW	CDX		
GNDER2525M2	GCMN20	25	25	150	30	31	2	5	CSH0620	LW040
GNDER2525M3	GCMN30	25	25	150	30.3	31	3	5	CSH0620	LW040
GNDXER2525M15	GXMN15	25	25	150	28.5	23	1.5	3.5	CSH0620	LW040
GNDXER2525M2	GXMN20	25	25	150	30.5	23	2	5.5	CSH0620	LW040

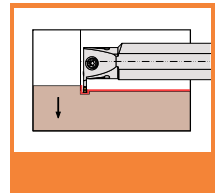
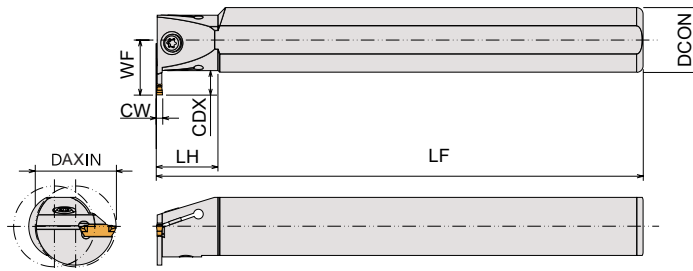

▼Recommended Inserts 建議刀片品牌：SUMITOMO GNDISR with coolant, GNDISR-B without coolant

Order No.	Insert	Dimensions(mm)							Parts	Wrench
		柄徑 DCON	工作寬度 WF	長度 LF	最小加工徑 DAXIN	頭長 LH	切寬 CW	最大切深 CDX		
GNDISR1013-T2030	GXMN20	10	8	125	13	25	2	3	CS40090	TL-15
GNDISR1214-T2036		12	10	150	14	30	2	3.6	CS40090	TL-15
GNDISR1616-T2036		16	11.5	160	16	35	2	3.6	CS50100	TL-20N
GNDISR1620-T2046		16	13	160	20	40	2	4.6	CS50100	TL-20N
GNDISR1214-T3040	GXMN30	12	10.5	150	14	30	3	4	CS40090	TL-15
GNDISR1616-T3036		16	11.5	160	16	35	3	3.6	CS50100	TL-20N
GNDISR1620-T3050		16	13.5	160	20	40	3	5	CS50100	TL-20N
GNDISR1013-T2030B	GXMN20	10	8	125	13	15	2	3	CS40090	TL-15
GNDISR1214-T2036B		12	10	125	14	15	2	3.6	CS40090	TL-15
GNDISR1616-T2036B		16	11.5	125	16	20	2	3.6	CS50100	TL-20N
GNDISR1620-T2046B		16	13	125	20	20	2	4.6	CS50100	TL-20N
GNDISR2025-T2066B		20	17	150	25	20	2	6.6	CS50100	TL-20N
GNDISR1214-T3036B	GXMN30	12	10	125	14	15	3	3.6	CS40090	TL-15
GNDISR1214-T3040B		12	10.5	125	14	15	3	4	CS40090	TL-15
GNDISR1616-T3036B		16	11.5	125	16	15	3	3.6	CS50100	TL-20N
GNDISR1620-T3046B		16	13	150	20	20	3	4.6	CS50100	TL-20N
GNDISR1620-T3050B		16	13.5	125	20	20	3	5	CS50100	TL-20N
GNDISR2025-T3066B		20	17	150	25	20	3	6.6	CS50100	TL-20N

L-SIGER
KYOCERA

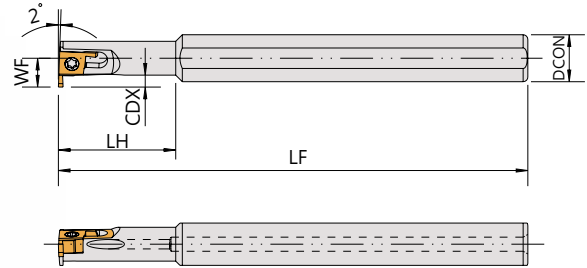
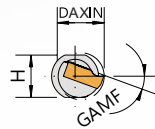
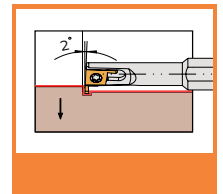
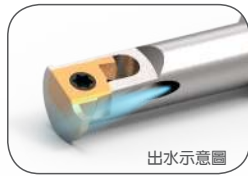

▼Recommended Inserts 建議刀片品牌：KYOCERA

Order No.	Insert	Dimensions(mm)						Parts	Wrench
		柄徑	工作寬度	長度	最小加工徑	頭長	最大切深		
Right / Left		DCON	WF	LF	DAXIN	LH	CDX		
L08H-SIGER08A	GER100 ~ 200-A	8	4.8	100	8	20	1.5	CS20038	FT-6
L10K-SIGER10B	GER100 ~ 300-B	10	6.2	125	10	25	2.2	CS22050	FT-7
L10K-SIGER12B		10	7.0	125	12	30	2.2	CS22050	FT-7
L12M-SIGER14B		12	8.0	150	14	30	2.2	CS22050	FT-7
L16M-SIGER14B-L20		16	8.0	150	14	20	2.2	CS22050	FT-7
L20M-SIGER16C-L20	GER100~ 300-C	20	9.0	150	16	20	2.5	CS25061S	FT-7
L25M-SIGER25C-L20		25	13.5	150	25	20	2.5	CS25061S	FT-7
L25M-SIGER25C		25	13.5	150	25	45	2.5	CS25061S	FT-7

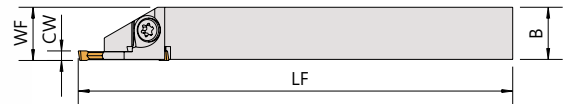
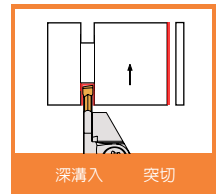

▼Recommended Inserts 建議刀片品牌：ISCAR

Order No.	Insert	Dimensions(mm)							Parts	Wrench
		柄高 H	柄寬 B	長度 LF	工作寬度 WF	頭長 LH	切寬 CW	最大切深 CDX		
DGTR/L12B-1.4D24SH	DGN14	12	12	120	12.2	19	1.4	12	CS35117S	FT-15
DGTR/L12B-1.5D24SH	DGN15	12	12	120	12.2	19	1.5	12		FT-15
DGTR/L12B-2D24SH	DGN20	12	12	120	12.2	19	2	12		FT-15
DGTR/L1612B-2D24SH		16	12	120	12.2	19	2	12		FT-15
DGTR/L16B-2D25SH	DGN30	16	16	120	16.2	19.5	2	12.5		FT-15
DGTR/L16B-3D25SH		16	16	120	16.3	19.5	3	12.5		FT-15
DGTR/L20B-3D25SH		20	20	120	20.3	19.5	3	12.5	FT-15	
DGTR/L16B-3D34		16	16	140	16.3	30	3	17	CSH0520	LW040
DGTR/L20B-3D40	20	20	140	20.3	36	3	20	CSH0520	LW040	

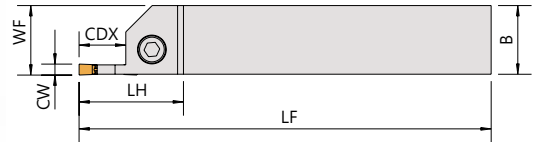
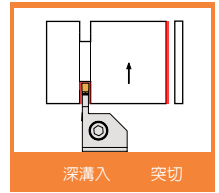

▼ Recommended Inserts 建議刀片品牌: KORLOY

Order No.	Insert	Dimensions(mm)							Parts	Wrench
		柄高	柄寬	長度	工作寬度	頭長	切寬	最大切深		
Right / Left		H	B	LF	WF	LH	CW	CDX		
GHDR-1616H02-10 KO	MGMN200	16	16	100	16.15	32	2	10	CSH0514	LW040
GHDR-2020K02-14 KO	MGMN200 MGMR200	20	20	125	20.3	32	2	14	CSH0616	LW050
GHDR-2525M02-14 KO		25	25	150	25.2	30	2	14	CSH0620	LW050
GHDR-2525M02-20 KO		25	25	150	25.3	35	2	20	CSH0620	LW050
GHDR-1616H03-16 KO	MGMN300 MGGN300 MRMN300 MGMR300	16	16	100	16.3	32	3	16	CSH0514	LW040
GHDR-2020K03-10 KO		20	20	125	20.3	30	3	10	CSH0616	LW050
GHDR-2020K03-20 KO		20	20	125	20.3	32	3	20	CSH0616	LW050
GHDR-2525M03-10 KO		25	25	150	25.3	35	3	10	CSH0620	LW050
GHDR-2525M03-16 KO		25	25	150	25.3	35	3	16	CSH0620	LW050
GHDR-2525M03-20 KO		25	25	150	25.3	35	3	20	CSH0620	LW050
GHDR-2020K04-20 KO	MGMN400 MGGN400 MRMN400 MGMR400	20	20	125	20.3	38	4	20	CSH0616	LW050
GHDR-2525M04-10 KO		25	25	150	25.3	30	4	10	CSH0620	LW050
GHDR-2525M04-16 KO		25	25	150	25.3	38	4	16	CSH0620	LW050
GHDR-2525M04-20 KO		25	25	150	25.3	38	4	20	CSH0620	LW050
GHDR-2525M05-16 KO	MGMN500 MGGN500 MRMN500 MGMR500	25	25	150	25.3	38.7	5	16	CSH0620	LW050
GHDR-2525M05-20 KO		25	25	150	25.3	38.7	5	20	CSH0620	LW050

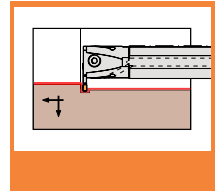
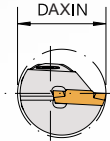

with coolant 含水孔

▼Recommended Inserts 建議刀片品牌: KORLOY

Order No.	Insert	Dimensions(mm)							Parts	Wrench
		柄徑	工作寬度	長度	最小加工徑	頭長	切寬	最大切深		
Right / Left		DCON	WF	LF	DAXIN	LH	CW	CDX		
MGIVR-2016M2	MGMN200 MGMR200	16	12	150	20	25	2	4	CSH0310	LW025
MGIVR-2520M2		20	14.5	150	25	25	2	4	CSH0512	LW040
MGIVR-2925R2		25	16	200	29	30	2	4	CSH0516	LW040
MGIVR-2620M3	MGMN300 MGGN300 MRMN300 MGMR300	20	16.5	150	26	25	3	6	CSH0512	LW040
MGIVR-3020M3		20	20	150	30	25	3	10	CSH0512	LW040
MGIVR-3125R3		25	18	200	31	30	3	6	CSH0516	LW040
MGIVR-3525R3		25	22	200	35	30	3	10	CSH0516	LW040
MGIVR-3832S3		32	21.5	250	38	40	3	6	CSH0516	LW040
MGIVR-4232S3		32	25.5	250	42	40	3	10	CSH0516	LW040
MGIVR-2620M4		MGMN400 MGGN400 MRMN400 MGMR400	20	15.5	150	26	25	4	6	CSH0512
MGIVR-3020M4	20		20	150	30	25	4	10	CSH0512	LW040
MGIVR-3125R4	25		18.5	200	31	30	4	6	CSH0516	LW040
MGIVR-3525R4	25		22.5	200	35	30	4	10	CSH0516	LW040
MGIVR-3832S4	32		22	250	38	40	4	6	CSH0516	LW040
MGIVR-4232S4	32		26	250	42	40	4	10	CSH0516	LW040
MGIVR-5040T4	40		29.5	300	50	45	4	10	CSH0516	LW040
MGIVR-5540T4	40		34.5	300	55	45	4	15	CSH0516	LW040
MGIVR-3125R5	MGMN500 MGGN500 MRMN500 MGMR500	25	18	200	31	30	5	6	CSH0516	LW040

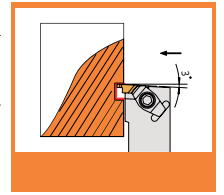
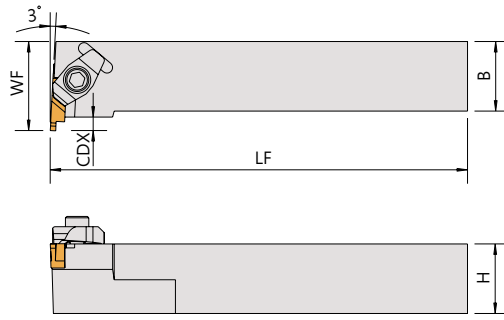
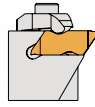

▼ Recommended Inserts 建議刀片品牌 : KENAMETAL/WIDIA

Order No.	Insert	Dimensions(mm)					Parts		Wrench	
		柄高 H	柄寬 B	長度 LF	工作寬度 WF	最大切深 CDX	Clamp R L			
UER/L-1616H2	N**R/L2 / NG2M	16	16	100	20	3.5	CPK4	CPK3	CSH3512	LW025
UER/L-2020K2		20	20	125	25	3.5	CPK4	CPK3	CSH3512	LW025
UER/L-2525M2		25	25	150	32	3.5	CPK4	CPK3	CSH3512	LW025
UER/L-2020K3	N**R/L3 / NG3M	20	20	125	25	3.8	CPK2	CPK1	CSH0516	LW040
UER/L-2525M3		25	25	150	32	5.3	CPK2	CPK1	CSH0516	LW040
UER/L-3225P3		32	25	170	40	5.3	CPK2	CPK1	CSH0516	LW040
UER/L-2525M4	N**R/L4	25	25	150	32	7.5	CPK2	CPK1	CSH0516	LW040

N**L: Right hand insert 右手刀片 N**R: Left hand insert 左手刀片

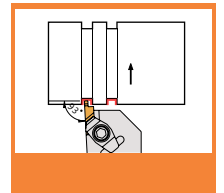
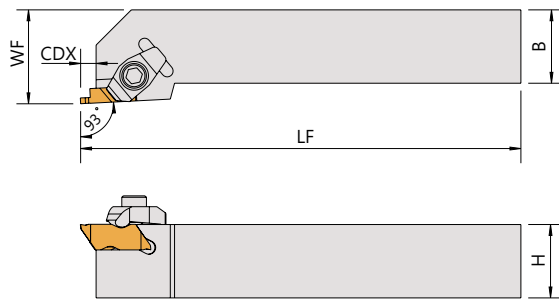
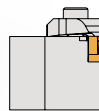

▼ Recommended Inserts 建議刀片品牌 : KENAMETAL/WIDIA

Order No.	Insert	Dimensions(mm)					Parts		Wrench	
		柄高 H	柄寬 B	長度 LF	工作寬度 WF	最大切深 CDX	Clamp R L			
USR/L-1212F2	N**R/L2 / NG2M	12	12	80	16	3.5	CPK3	CPK4	CSH3512	LW025
USR/L-1616H2		16	16	100	20	3.5	CPK3	CPK4	CSH3512	LW025
USR/L-2020K2		20	20	125	25	3.5	CPK3	CPK4	CSH3512	LW025
USR/L-2525M2		25	25	150	32	3.5	CPK3	CPK4	CSH3512	LW025
USR/L-2020K3	N**R/L3 / NG3M	20	20	125	25	5.3	CPK1	CPK2	CSH0516	LW040
USR/L-2525M3		25	25	150	32	5.3	CPK1	CPK2	CSH0516	LW040
USR/L-3225P3		32	25	170	32	5.3	CPK1	CPK2	CSH0516	LW040
USR/L-3232P3		32	32	170	40	5.3	CPK1	CPK2	CSH0516	LW040
USR/L-2525M4	N**R/L4	25	25	150	32	5.3	CPK1	CPK2	CSH0516	LW040
USR/L-3225P4		25	25	170	32	5.3	CPK1	CPK2	CSH0516	LW040

UASR KENNAMETAL

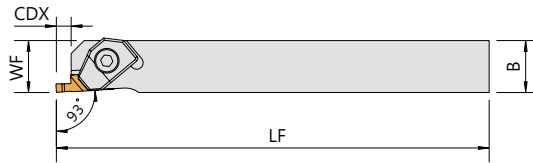
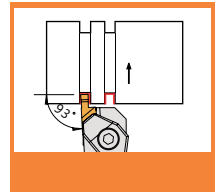

▼Recommended Inserts 建議刀片品牌: KENNAMETAL/WIDIA/ACC

Order No.	Insert	Dimensions(mm)					Parts		Wrench	
		柄高	柄寬	長度	工作寬度	最大切深	Clamp			
Right / Left		H	B	LF	WF	CDX	R	L		
UASR/L-1010M2Q	N**R/L2	10	10	150	10	3.5	CPK3A	CPK4A	CSH3512	LW025
UASR/L-1212M2Q	/ NG2M	12	12	150	12	3.5	CPK3A	CPK4A	CSH3512	LW025
UASR/L-1616K3Q	N**R/L3 / NG3M	16	16	125	16	5.3	CPK1	CPK2	CSH0516	LW040

S-UNTOR KENNAMETAL

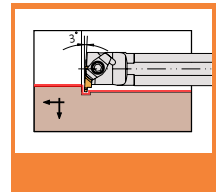
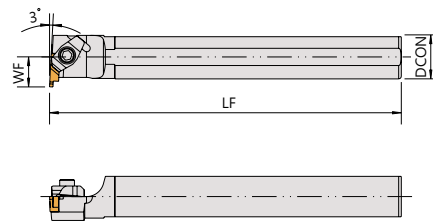
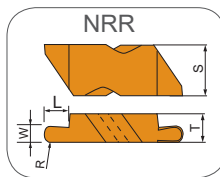
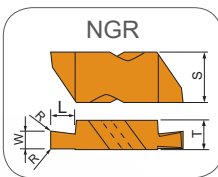

▼Recommended Inserts 建議刀片品牌: KENNAMETAL/WIDIA

Order No.	Insert	Dimensions(mm)				Parts		Wrench	
		柄徑	工作寬度	長度	最小加工徑	Clamp			
Right / Left		DCON	WF	LF	DAXIN	R	L		
S12M-UNTOR/L2	N*L/R2 / NG2M	12	11	150	18.5	CPK4B	CPK3B	CSH3512	LW025
S16M-UNTOR/L2		16	11	150	22.0	CPK4	CPK3	CSH3512	LW025
S20Q-UNTOR/L2		20	13	180	26.0	CPK4	CPK3	CSH3512	LW025
S25R-UNTOR/L2		25	17	200	34.0	CPK4	CPK3	CSH3512	LW025
S25R-UNTOR/L3	N*L/R3 / NG3M	25	17	200	34.0	CPK2	CPK1	CSH0516	LW040
S32S-UNTOR/L3		32	22	250	44.0	CPK2	CPK1	CSH0516	LW040
S40T-UNTOR/L3		40	27	300	54.0	CPK2	CPK1	CSH0516	LW040

Ordering Code	UN123	W	L	R	T	S
NGR21000	*	1.00	1.3	0.0	3.81	5.56
NGR21500	*	1.50	2.8	0.0	3.81	5.56
NGR22020	*	2.00	2.8	0.2	3.81	5.56
NGR22520	*	2.50	2.8	0.2	3.81	5.56
NGR31500	*	1.50	2.4	0.0	4.95	8.74
NGR32020	*	2.00	2.4	0.2	4.95	8.74
NGR32520	*	2.50	3.8	0.2	4.95	8.74
NGR33020	*	3.00	3.8	0.2	4.95	8.74

Ordering Code	UN123	W	L	R	T	S
NRR210050	*	1.00	1.5	0.50	3.81	5.56
NRR215075	*	1.50	2.5	0.75	3.81	5.56
NRR220100	*	2.00	2.5	1.00	3.81	5.56
NRR225125	*	2.50	2.5	1.25	3.81	5.56
NRR320100	*	2.00	2.0	1.00	4.95	8.74
NRR325125	*	2.50	3.5	1.25	4.95	8.74
NRR330150	*	3.00	3.5	1.50	4.95	8.74
NRR335175	*	3.50	3.5	1.75	4.95	8.74
NRR340200	*	4.00	3.5	2.00	4.95	8.74
NRR345225	*	4.50	3.5	2.25	4.95	8.74

N**L: Right hand insert 右手刀片

N**R: Left hand insert 左手刀片

S-USR
90°

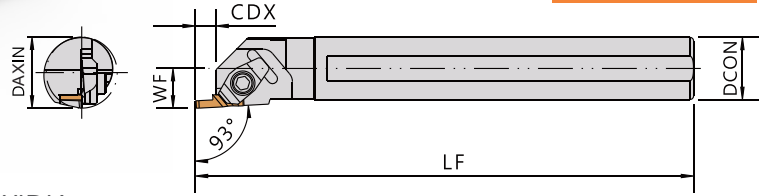
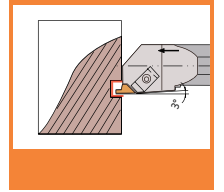

▼Recommended Inserts 建議刀片品牌: KENNAMETAL/WIDIA

Order No.	Insert	Dimensions(mm)					Parts		Wrench
		柄徑 DCON	工作寬度 WF	長度 LF	最小加工徑 DAXIN	最大切深 CDX	Clamp		
S20Q-USR2	N*R2 / NG2M	20	14	180	22	4	CPK3	CSH3512	LW025
S25R-USR3	N*R3 / NG3M	25	16	200	48	8	CPK1	CSH0516	LW040
S32S-USR3		32	20	250	52	8	CPK1	CSH0516	LW040
S40S-USR3		40	23	250	57	8	CPK1	CSH0516	LW040
S50T-USR3		50	32.5	300	60	8	CPK1	CSH0516	LW040

GWCS
SUMITOMO

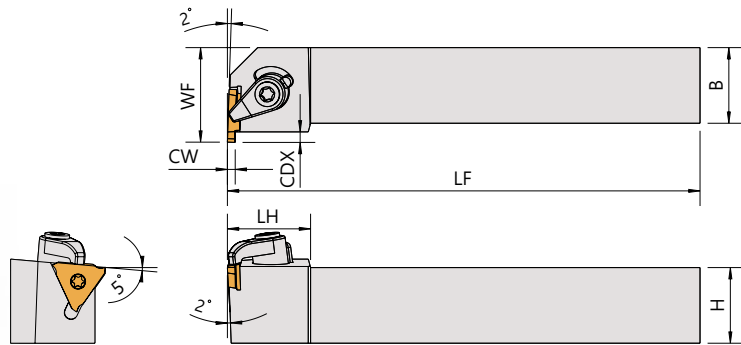
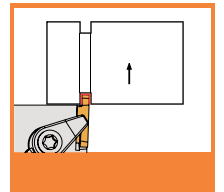

▼Recommended Inserts 建議刀片品牌: SUMITOMO

Order No.	Insert	Dimensions(mm)						
		柄高 H	柄寬 B	長度 LF	工作寬度 WF	頭長 LH	切寬 CW	最大切深 CDX
GWCSR/L2525-3	TGAR3	25	25	150	25	22	3	30
GWCSR/L2525-15	TGAR4	25	25	150	32	22	15	30

Parts				Wrench	
Insert screw	Clamp	Clamp screw	Washer	Insert wrench	Clamp wrench
CS40090	CP50-23	CSE5021	ER-04	FT-15	LW030
CS50100	CP50-23	CSE5021	ER-04	TL-20	LW030

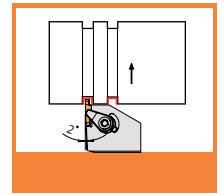
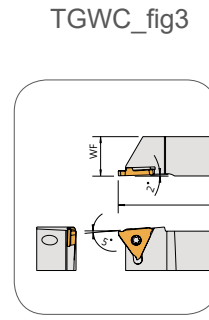
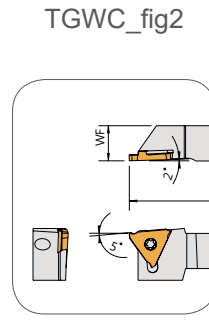
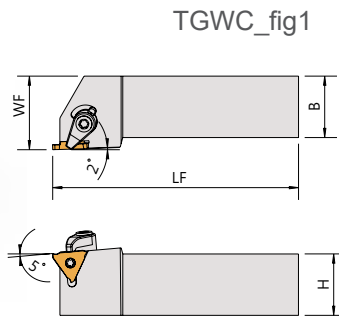

▼Recommended Inserts 建議刀片品牌: SUMITOMO

Order No.	Insert	Dimensions(mm)				Fig	Parts				Wrench	
		柄高 H	柄寬 B	長度 LF	工作寬度 WF		Insert screw	Clamp screw	Washer	Insert wrench	Clamp wrench	
TGWCR1010-3	TGAR3 T*R16	10	10	125	10	2	CS40090	-	-	-	TL-15	-
TGWCR1212-3		12	12	125	12	2	CS40090	-	-	-	TL-15	-
TGWCR1616-3		16	16	125	16	3	CS40090	-	-	-	TL-15	-
TGWCR2020-3		20	20	125	25	1	CS40090	CP50-23	CSE5021	ER04	TL-15	LW030
TGWCR2525-3		25	25	150	30	1	CS40090	CP50-23	CSE5021	ER04	TL-15	LW030
TGWCR2020-15	TGAR4 T*R22 (W1~1.45)	20	20	125	25	1	CS50100	CP50-23	CSE5021	ER04	TL-20	LW030
TGWCR2525-15		25	25	150	30	1	CS50100	CP50-23	CSE5021	ER04	TL-20	LW030
TGWCR2020-25	TGAR4 T*R22 (W1.5~2.3)	20	20	125	25	1	CS50100	CP50-23	CSE5021	ER04	TL-20	LW030
TGWCR2525-25		25	25	150	30	1	CS50100	CP50-23	CSE5021	ER04	TL-20	LW030
TGWCR2020-35	TGAR4 T*R22 (W2.5~4.8)	20	20	125	25	1	CS50100	CP50-23	CSE5021	ER04	TL-20	LW030
TGWCR2525-35		25	25	150	30	1	CS50100	CP50-23	CSE5021	ER04	TL-20	LW030

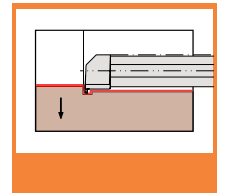
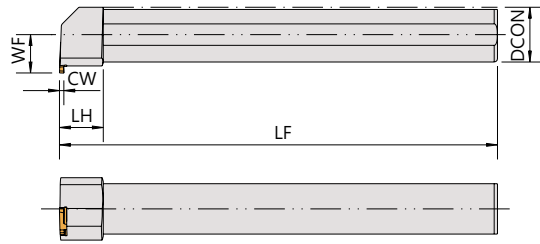
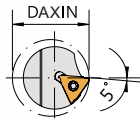

▼Recommended Inserts 建議刀片品牌：SUMITOMO

Order No.	Insert	Dimensions(mm)					Parts	Wrench
		柄徑 DCON	工作寬度 WF	長度 LF	最小加工徑 DAXIN	頭長 LH		
Right / Left								
GWCIR/L320-150	TGAR/L3	20	15	150	27	20	CS40090	TL-15
GWCIR/L320		20	15	200	27	20	CS40090	TL-15
GWCIR/L325		25	17.5	200	35	20	CS40090	TL-15
GWCIR/L432	TGAR/L4	32	22.5	200	40	25	CS50100	TL-20

TGAL/T*L: Right hand insert 右手刀片
 TGAR/T*R: Left hand insert 左手刀片

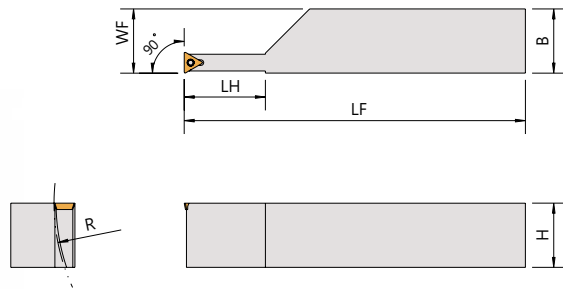
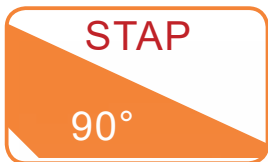

Order No.	Insert	Dimensions(mm)						Parts	Wrench
		柄高 H	柄寬 B	最小切削半徑 R	長度 LF	頭長 LH	工作寬度 WF		
Right / Left									
STAPR/L-2020K09	TP 0902	20	20	32	125	26	20	CS25065/ CS25062S	FT-8
STAPR/L-2525M09		25	25	43	150	30	25		
STAPR/L-3232P11	TP 1103	32	32	100	170	40	32	CSA30070	FT-10

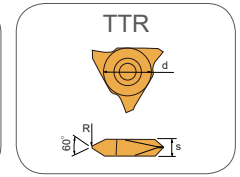
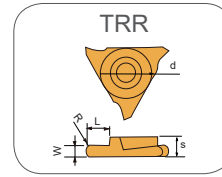
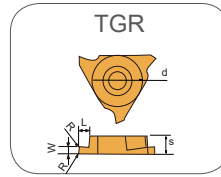
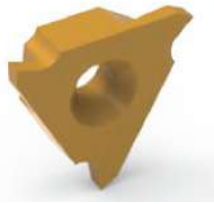

Ordering Code	UA3F2	W	L	R	d	S
TGR16050	*	0.50	1.4	0.00	9.525	3.18
TGR16075	*	0.75	2.5	0.10	9.525	3.18
TGR16095	*	0.95	2.5	0.10	9.525	3.18
TGR16100	*	1.00	2.5	0.10	9.525	3.18
TGR16125	*	1.25	2.5	0.10	9.525	3.18
TGR16135	*	1.35	2.5	0.10	9.525	3.18
TGR16150	*	1.50	2.5	0.20	9.525	3.18
TGR16200	*	2.00	3.0	0.20	9.525	3.18
TGR22100	*	1.00	2.5	0.10	12.70	4.76
TGR22125	*	1.25	2.5	0.20	12.70	4.76
TGR22135	*	1.35	2.5	0.20	12.70	4.76
TGR22145	*	1.45	2.5	0.20	12.70	4.76
TGR22150	*	1.50	3.9	0.20	12.70	4.76
TGR22200	*	2.00	3.9	0.20	12.70	4.76
TGR22250	*	2.50	5.4	0.30	12.70	4.76
TGR22300	*	3.00	5.4	0.30	12.70	4.76

Ordering Code	UA3F2	W	L	R	d	S
TRR22050	*	1.00	2.5	0.50	12.70	4.76
TRR22075	*	1.50	3.9	0.75	12.70	4.76
TRR22100	*	2.00	3.9	1.00	12.70	4.76
TRR22125	*	2.50	5.4	1.25	12.70	4.76
TRR22150	*	3.00	5.4	1.50	12.70	4.76
TRR22175	*	3.50	5.4	1.75	12.70	4.76
TRR22200	*	4.00	5.4	2.00	12.70	4.76

Ordering Code	UA3F2	Pitch (mm)	R	d	S
TTR226001	*	1.0~1.75	0.10	12.70	4.76
TTR226002	*	2.0~2.5	0.20	12.70	4.76